



CIVIL AVIATION DIRECTIVE – 14 VOL II

HELIPORTS

CIVIL AVIATION AUTHORITY OF MALAYSIA

ISSUE 02
REVISION 00 – 15TH MAY 2022

INTENTIONALLY LEFT BLANK

Introduction

In exercise of the powers conferred by section 24o of the Civil Aviation Act 1969 (Act 3), the Chief Executive Officer makes this Civil Aviation Directive 14 Vol. II ("CAD 14 Vol. II") – Heliports, pursuant to Regulation(s) 6, 12-14, 17-20, 22-24, 26-27, 29-31, 33-34, 37, 53-54, 64 of the Civil Aviation (Aerodrome Operations) Regulations 2016 (CAR(AO) 2016).

The standards and requirements in this CAD are based mainly on standards and recommended practices (SARPs) stipulated in International Civil Aviation Organisation (ICAO) Annex 14 Volume II to the Chicago Convention — Heliports

This CAD is published by the Chief Executive Officer under section 24o of the Civil Aviation Act 1969 (Act 3) and comes into effect on 15th May 2022.

Non-compliance with this CAD

Any person who contravenes any provision in this CAD commits an offence and shall on conviction be liable to the punishments under Section 24o (2) of the Civil Aviation Act 1969 [Act 3] and/or under Malaysia Civil Aviation Regulation 2016.



(Datuk Captain Chester Voo Chee Soon)
Chief Executive Officer
Civil Aviation Authority of Malaysia

Civil Aviation Directive components and Editorial practices

This Civil Aviation Directive is made up of the following components and are defined as follows:

Standards: Usually preceded by words such as “*shall*” or “*must*”, are any specification for physical characteristics, configuration, performance, personnel or procedure, where uniform application is necessary for the safety or regularity of air navigation and to which operators must conform. In the event of impossibility of compliance, notification to the CAAM is compulsory.

Recommended Practices: Usually preceded by the words such as “*should*” or “*may*”, are any specification for physical characteristics, configuration, performance, personnel or procedure, where the uniform application is desirable in the interest of safety, regularity or efficiency of air navigation, and to which operators will endeavour to conform.

Appendices: Material grouped separately for convenience but forms part of the Standards and Recommended Practices stipulated by the CAAM.

Definitions: Terms used in the Standards and Recommended Practices which are not self-explanatory in that they do not have accepted dictionary meanings. A definition does not have an independent status but is an essential part of each Standard and Recommended Practice in which the term is used, since a change in the meaning of the term would affect the specification.

Tables and Figures: These add to or illustrate a Standard or Recommended Practice and which are referred to therein, form part of the associated Standard or Recommended Practice and have the same status.

Notes: Included in the text, where appropriate, Notes give factual information or references bearing on the Standards or Recommended Practices in question but not constituting part of the Standards or Recommended Practices;

Attachments: Material supplementary to the Standards and Recommended Practices or included as a guide to their application.

It is to be noted that some Standards in this Civil Aviation Directive incorporates, by reference, other specifications having the status of Recommended Practices. In such cases, the text of the Recommended Practice becomes part of the Standard.

The units of measurement used in this document are in accordance with the International System of Units (SI) as specified in CAD 5. Where CAD 5 permits the use of non-SI alternative units, these are shown in parentheses following the basic units. Where two sets of units are quoted it must not be assumed that the pairs of values are equal and interchangeable. It may, however, be inferred that an equivalent level of safety is achieved when either set of units is used exclusively.

Any reference to a portion of this document, which is identified by a number and/or title, includes all subdivisions of that portion.

Throughout this Civil Aviation Directive, the use of the male gender should be understood to include male and female persons



INTENTIONALLY LEFT BLANK

**Summary of Changes**

ISS/REV no.	Item no.	Revision Details
ISS02/REV00	Introduction	Change of effective date of this CAD
	Paragraph 1.1	Change in Citation content
	Paragraph 1.2	Added <i>Note 2</i> .
	Paragraph 1.2.2	Amendment.
	Paragraph 1.4	Editorial changes.
	Paragraph 1.5	ICAO reference change to CAD reference.
	Paragraph 1.6	Remove and incorporated into 1.2.
	Paragraph 2.1 and 2.6	ICAO reference change to CAD reference.
	Paragraph 3.1	Added subtitles.
	Paragraph 3.2	Added <i>Note 2</i> and <i>3</i> .
	Paragraph 3.2.1 and 3.2.6	Amendment.
	Paragraph 3.2.9 and Table 3-2	Remove and incorporated into CAD 1406.
	Paragraph 3.2.11 and 3.2.12	Amendment.
	Paragraph 3.2.14 and 3.2.15	Amendment.
	Paragraph 3.2.17 until 3.2.42	Remove and incorporated into CAD 1406.
	Paragraph 3.3.1	Amendment.
	Paragraph 3.3.9	Amendment.
	Paragraph 3.3.10 until 3.3.12	Amendment.
	Paragraph 3.3.14 until 3.3.17	Amendment.
	Paragraph 3.3.18	Note removed.
Paragraph 4.1.22 until 4.1.26	Amendment.	
Paragraph 4.2.12 until 4.2.29	Amendment.	



Paragraph 4.2.30 until 4.2.54	Removed.
Paragraph 5.2.3	Amendment.
Paragraph 5.2.3.5	Amendment.
Paragraph 5.2.4.1	Amendment.
Paragraph 5.2.9.7	Amendment.
Paragraph 5.2.10.7 until 5.2.10.9	Removed and incorporated into CAD 1406.
Paragraph 5.2.11.2	Amendment.
Paragraph 5.2.11.4	Amendment.
Paragraph 5.2.11.6	Amendment.
Paragraph 5.2.11.7 until 5.2.11.10	Removed and incorporated into CAD 1406.
Figure 5-9	Removed and incorporated into CAD 1406.
Paragraph 5.2.17	Removed and incorporated into CAD 1406.
Paragraph 5.3.3.1	Amendment.
Paragraph 5.3.4.1	Amendment.
Paragraph 5.3.9.3	Note 2 removed.
Paragraph 5.3.9.18	Amendment.
Paragraph 5.3.15 and 5.3.16	Removed and incorporated into CAD 1406.
Chapter 5	Multiple figures number changes. (e.g. Figure 5-11 change to 5-10)
Paragraph 6.1.8	Note removed.
Paragraph 6.2.2.1	Note removed.
Paragraph 6.2.3	Amendment.
Paragraph 6.2.4.2	Note removed.
Chapter 7	Removed and incorporated into CAD 1406.



Table of Contents

1	GENERAL	1-1
1.1	CITATION	1-1
1.2	APPLICABILITY	1-1
1.3	REVOCATION	1-2
1.4	DEFINITIONS, ABBREVIATIONS AND SYMBOLS	1-2
1.5	RELATED REFERENCE DOCUMENTS	1-6
1.6	<i>RESERVED</i>	1-7
1.7	COMMON REFERENCE SYSTEMS	1-7
2	HELIPORT DATA	2-1
2.1	AERONAUTICAL DATA	2-1
2.2	HELIPORT REFERENCE POINT	2-1
2.3	HELIPORT ELEVATIONS	2-1
2.4	HELIPORT DIMENSIONS AND RELATED INFORMATION	2-1
2.5	DECLARED DISTANCES	2-2
2.6	COORDINATION BETWEEN AERONAUTICAL INFORMATION SERVICES AND HELIPORT AUTHORITIES	2-3
2.7	RESCUE AND FIREFIGHTING	2-4
3	PHYSICAL CHARACTERISTICS	3-1
3.1	ONSHORE HELIPORTS	3-1
3.2	HELIDECKS	3-15
3.3	SHIPBOARD HELIPORTS	3-18
4	OBSTACLE ENVIRONMENT	4-1
4.1	OBSTACLE LIMITATION SURFACES AND SECTORS	4-1
4.2	OBSTACLE LIMITATION REQUIREMENTS	4-5
5	VISUAL AIDS	5-1
5.1	INDICATORS	5-1
5.2	MARKINGS AND MARKERS	5-2
5.3	LIGHTS	5-21
6	HELIPORT EMERGENCY RESPONSE	6-1
6.1	HELIPORT EMERGENCY PLANNING	6-1
6.2	RESCUE AND FIREFIGHTING	6-2
7	APPENDICES	7-1
7.1	APPENDIX 1 – INTERNATIONAL STANDARDS AND RECOMMENDED PRACTICES FOR INSTRUMENT HELIPORTS WITH NON-PRECISION AND/OR PRECISION APPROACHES AND INSTRUMENT DEPARTURES	7-1



INTENTIONALLY LEFT BLANK

1 General

1.1 Citation

1.1.1 These Directives are the Civil Aviation Directives 14 Vol. II – Heliports, Issue 01/Revision 00, and comes into operation on 15th May 2022.

1.1.2 This CAD 14 Vol. II, Issue 02/Revision 00 will remain current until withdrawn or superseded.

1.2 Applicability

Note 1. — This CAD contains Standards that prescribe the physical characteristics and obstacle limitation surfaces to be provided for at heliports, and certain facilities and technical services normally provided at a heliport. It is not intended that these specifications limit or regulate the operation of an aircraft.

When designing a heliport, the critical design helicopter, having the largest set of dimensions and the greatest maximum take-off mass (MTOM) the heliport is intended to serve, would need to be considered.

It is to be noted that provisions for helicopter flight operations are contained in CAD 6, Part III.

Note 2. — The dimensions discussed in this CAD are based on consideration of single-main-rotor helicopters. For tandem-rotor helicopters the heliport design will be based on a case-by-case review of the specific models using the basic requirement for a safety area and protection areas specified in this CAD. The specifications of the main chapters of this CAD are applicable for visual heliports that may or may not incorporate the use of a Point-in-space approach or departure. Additional specifications for instrument heliports with non-precision and/or precision approaches and instrument departures are detailed in Appendix 1. The specifications of this CAD are not applicable for water heliports (touchdown or lift-off on the surface of the water).

1.2.1 The Standards contained in this CAD shall be read together with CAD 14 Vol. I – Aerodrome Design and Operations shall be applicable to standards that prescribe the physical characteristics and obstacle limitation surfaces to be provided for at aerodromes and at any matter related thereto, including certain facilities and technical services normally provided at an aerodrome.

1.2.2 Heliports intended to be used by commercial air transport aircraft shall be certified in accordance with the specifications contained in this Directive as well as another relevant ICAO document.

Note. — Specific procedures on the stages of certifying an aerodrome are given in the CAD 1405 – Certification and Surveillance of Aerodrome. Further guidance on aerodrome certification can be found in the CAGM 1405 – Certification and Surveillance of Aerodrome.



- 1.2.3 The interpretation of some of the specifications in this CAD requires the exercising of discretion, the taking of a decision or the performance of a function by the CAAM. In other specifications, the expression CAAM does not actually appear although its inclusion is implied. In both cases, the responsibility for whatever determination or action is necessary shall rest with the CAAM having jurisdiction over the heliport.
- 1.2.4 The specifications in this CAD shall apply to all heliports intended to be used by commercial air transport aircraft. They shall apply equally to areas for the exclusive use of helicopters at an aerodrome primarily meant for the use of aeroplanes. Where relevant, the provisions of CAD 14 Vol. I shall apply to the helicopter operations being conducted at such an aerodrome.
- 1.2.5 Unless otherwise specified, the specification for a colour referred to within this CAD shall be that contained in Appendix 1 to CAD 14 Vol. I.

1.3 Revocation

- 1.3.1 This CAD, revokes all Airport Standards Directives related to ICAO Annex 14 Volume II.

1.4 Definitions, Abbreviations and Symbols

- 1.4.1 CAD 14 Vol. I, contains definitions for the terms which are used in both volumes. Those definitions are not reproduced in this volume, with the exception of the following two, which are included for ease of reference:

Heliport means an aerodrome or a defined area on a structure intended to be used wholly or in part for the arrival, departure and surface movement of helicopters.

Obstacle means all fixed (whether temporary or permanent) and mobile objects, or parts thereof, that:

- a) are located on an area intended for the surface movement of aircraft; or
- b) extend above a defined surface intended to protect aircraft in flight; or
- c) stand outside those defined surfaces and that have been assessed as being a hazard to air navigation.

The following list contains definitions of terms that are used only in Volume II, with the meanings given below.

D means the largest overall dimension of the helicopter when rotor(s) are turning measured from the most forward position of the main rotor tip path plane to the most rearward position of the tail rotor tip path plane or helicopter structure.

Design D means the D of the design helicopter.

D-value means a limiting dimension, in terms of “D”, for a heliport, helideck or shipboard heliport, or for a defined area within.

Declared distances — heliports means.

- a) *Take-off distance available (TODAH)*. The length of the FATO plus the length of helicopter clearway (if provided) declared available and suitable for helicopters to complete the take-off.
- b) *Rejected take-off distance available (RTODAH)*. The length of the FATO declared available and suitable for helicopters operated in performance class 1 to complete a rejected take-off.
- c) *Landing distance available (LDAH)*. The length of the FATO plus any additional area declared available and suitable for helicopters to complete the landing manoeuvre from a defined height.

Dynamic load-bearing surface means a surface capable of supporting the loads generated by a helicopter in motion.

Elevated heliport means a heliport located on a raised structure on land.

Final approach and take-off area (FATO) means a defined area over which the final phase of the approach manoeuvre to hover or landing is completed and from which the take-off manoeuvre is commenced. Where the FATO is to be used by helicopters operated in performance class 1, the defined area includes the rejected take-off area available.

Helicopter clearway means a defined area on the ground or water, selected and/or prepared as a suitable area over which a helicopter operated in performance class 1 may accelerate and achieve a specific height.

Helicopter stand means an aircraft stands which provides for parking a helicopter and where ground taxi operations are completed or where the helicopter touches down and lifts off for air taxi operations.

Helicopter taxiway means a defined path on a heliport intended for the ground movement of helicopters and that may be combined with an air taxi-route to permit both ground and air taxiing.

Helicopter taxi-route means a defined path established for the movement of helicopters from one part of a heliport to another.

- a) *Air taxi-route*. A marked taxi-route intended for air taxiing.
- b) *Ground taxi-route*. A taxi-route centred on a taxiway.

Helideck means a heliport located on a fixed or floating offshore facility such as an exploration and/or production unit used for the exploitation of oil or gas.

Helicopter landing officer is a designated person on duty at an off-shore installation responsible for supporting safe helicopter operations to the helideck and the daily supervision of the helideck

Helideck radio operator is a designated person responsible for ensuring effective radio communications between helicopter flight crew and the helideck.



Heliport elevation is the elevation of the highest point of the FATO.

Heliport reference point (HRP) is the designated location of a heliport or a landing location.

Normally Unmanned Installation (fixed helideck) is an offshore installation designed to be primarily operated remotely, without the constant presence of personnel.

Point-in-space approach (Pins) is the Point-in-space approach is based on GNSS and is an approach procedure designed for helicopter only. It is aligned with a reference point located to permit subsequent flight manoeuvring or approach and landing using visual manoeuvring in adequate visual conditions to see and avoid obstacles.

Point-in-space (Pins) visual segment is the segment of a helicopter Pins approach procedure from the Map to the landing location for a Pins “proceed visually” procedure. This visual segment connects the Point-in-space (Pins) to the landing location.

Note. — The procedure design criteria for a Pins approach and the detailed design requirements for a visual segment are established in the ICAO Procedures for Air Navigation Services — Aircraft Operations, (PANS-OPS, Doc 8168).

Protection area is a defined area surrounding a stand intended to reduce the risk of damage from helicopters accidentally diverging from the stand.

Rejected take-off area is a defined area on a heliport suitable for helicopters operating in performance class 1 to complete a rejected take-off.

Runway-type FATO is a FATO having characteristics similar in shape to a runway.

Safety area means a defined area on a heliport surrounding the FATO which is free of obstacles, other than those required for air navigation purposes, and intended to reduce the risk of damage to helicopters accidentally diverging from the FATO.

Shipboard heliport means a heliport located on a ship that may be purpose or non-purpose-built. A purpose-built shipboard heliport is one designed specifically for helicopter operations. A non-purpose-built shipboard heliport is one that utilises an area of the ship that is capable of supporting a helicopter but not designed specifically for that task.

Static load-bearing surface means a surface capable of supporting the mass of a helicopter situated upon it.

Surface-level heliport means a heliport located on the ground or on a structure on the surface of the water.

Touchdown and lift-off area (TLOF) means an area on which a helicopter may touch down or lift off.

Winching area means an area provided for the transfer by helicopter of personnel or stores to or from a ship.



1.4.2 Abbreviations and symbols used in CAD 14 Vol. II.

Abbreviations

AIP	Aeronautical Information Publication	OFS	Obstacle-free sector
APAPI	Abbreviated precision approach path indicator	OLS	Obstacle limitation surface
ASPSL	Arrays of segmented point source Lighting	PAPI	Precision Approach Path Indicator
CAAM	Civil Aviation Authority of Malaysia	PFAS	Portable Foam Application System
CAD	Civil Aviation Directive	Pins	Point-in-space
cd	Candela	RFF	Rescue and firefighting
cm	Centimetre	RFFS	Rescue and Firefighting Service
DIFFS	Deck Integrated Firefighting system	R/T	Radiotelephony or radio communications
FAS	Fixed application system	RTOD	Rejected take-off distance
FATO	Final approach and take-off area	RTODAH	Rejected take-off distance available
FFAS	Fixed foam application system	s	Second
FMS	Fixed monitor system	tonne	1000 kg
ft.	Foot	TDPC	Touchdown/positioning Circle
GNSS	Global Navigation Satellite System	TDPM	Touchdown/positioning marking
HAPI	Helicopter Approach Path Indicator	TLOF	Touchdown and lift-off area
HFM	Helicopter Flight Manual	TODAH	Take-off distance available
HLO	Helicopter Landing Officer	UCW	Undercarriage width
HRO	Heliport Radio Operator	VASI	Visual Approach Slope Indicator
Hz	Hertz	VSS	Visual Segment Surface
kg	Kilogramme		
km/h	Kilometre per hour	Symbols	
kt	Knot	°	Degree
L	Litre	=	Equals
lb.	Pounds	%	Percentage
LDAH	Landing Distance Available	±	plus or minus
L/min	Litre per minute		
LOA	Limited Obstacle Area		
LOS	Limited Obstacle Sector		
LP	Luminescent Panel		
m	Metre		
Map	Missed approach point		
MTOM	Maximum take-off mass		
NVIS	Night Vision Imaging Systems		



1.5 Related reference documents

1.5.1 This CAD shall be read in conjunction with the list of reference documents below:

Aerodrome Design Manual (Doc 9157)

Part 1 — Runways

Part 2 — Taxiways, Aprons and Holding Bays

Part 3 — Pavements

Part 4 — Visual Aids

Part 5 — Electrical Systems

Part 6 — Frangibility

Aeronautical Information Services Manual (Doc 8126)

Airport Planning Manual (Doc 9184)

Part 1 — Master Planning

Part 2 — Land Use and Environmental Control

Part 3 — Guidelines for Consultant/Construction Services

Airport Services Manual (Doc 9137)

Part 1 — Rescue and Fire Fighting

Part 2 — Pavement Surface Conditions

Part 3 — Wildlife Control and Reduction

Part 4 — Fog Dispersal (withdrawn)

Part 5 — Removal of Disabled Aircraft

Part 6 — Control of Obstacles

Part 7 — Airport Emergency Planning

Part 8 — Airport Operational Services

Part 9 — Airport Maintenance Practices

Heliport Manual (Doc 9261)

Procedures for Air Navigation Services — Aeronautical Information Management (PANS-AIM) (Doc 10066)

Procedures for Air Navigation Services — Aircraft Operations (PANS-OPS) (Doc 8168)

Volume I — Flight Procedures

Volume II — Construction of Visual and Instrument Flight Procedures

World Geodetic System — 1984 (WGS-84) Manual (Doc 9674)

1.6 *RESERVED*

1.7 Common reference systems

1.7.1 Horizontal reference system

1.7.1.1 World Geodetic System — 1984 (WGS-84) shall be used as the horizontal (geodetic) reference system. Reported aeronautical geographical coordinates (indicating latitude and longitude) shall be expressed in terms of the WGS-84 geodetic reference datum.

Note. — Comprehensive guidance material concerning WGS-84 is contained in the World Geodetic System — 1984 (WGS-84) ICAO Manual (Doc 9674).

1.7.2 Vertical reference system

1.7.2.1 Mean sea level (MSL) datum, which gives the relationship of gravity-related height (elevation) to a surface known as the geoid, shall be used as the vertical reference system.

Note 1. — The geoid globally most closely approximates MSL. It is defined as the equipotential surface in the gravity field of the Earth which coincides with the undisturbed MSL extended continuously through the continents.

Note 2. — Gravity-related heights (elevations) are also referred to as optometric heights while distances of points above the ellipsoid are referred to as ellipsoidal heights.

1.7.3 Temporal reference system

1.7.3.1 The Gregorian calendar and Coordinated Universal Time (UTC) shall be used as the temporal reference system.

1.7.3.2 When a different temporal reference system is used, this shall be indicated in GEN 2.1.2 of the Aeronautical Information Publication (AIP)



INTENTIONALLY LEFT BLANK

2 Heliport data

2.1 Aeronautical data

2.1.1 Determination and reporting of heliport-related aeronautical data shall be in accordance with the accuracy and integrity classification required to meet the needs of the end-users of aeronautical data.

Note. — Specifications concerning the accuracy and integrity classification of heliport-related aeronautical data are contained in the CAD 1501 – Aeronautical Information Management.

2.1.2 Digital data error detection techniques shall be used during the transmission and/or storage of aeronautical data and digital data sets.

Note. — Detailed specifications concerning digital data error detection techniques are contained in the CAD 1501 – Aeronautical Information Management.

2.2 Heliport reference point

2.2.1 A heliport reference point shall be established for a heliport not collocated with an aerodrome.

Note. — When the heliport is collocated with an aerodrome, the established aerodrome reference point serves both aerodrome and heliport.

2.2.2 The heliport reference point shall be located near the initial or planned geometric centre of the heliport and shall normally remain where first established.

2.2.3 The position of the heliport reference point shall be measured and reported to the aeronautical information services authority in degrees, minutes and seconds.

2.3 Heliport elevations

2.3.1 The heliport elevation and geoid undulation at the heliport elevation position shall be measured and reported to aeronautical information services to the accuracy of one-half metre or foot.

2.3.2 The elevation of the TLOF and/or the elevation and geoid undulation of each threshold of the FATO (where appropriate) shall be measured and reported to aeronautical information services to the accuracy of one-half metre or foot.

Note. — Geoid undulation must be measured in accordance with the appropriate system of coordinates.

2.4 Heliport dimensions and related information

2.4.1 The following data shall be measured or described, as appropriate, for each facility provided on a heliport:

- a) heliport type — surface-level, elevated, shipboard or helideck;

- b) TLOF — dimensions to the nearest metre or foot, slope, surface type, bearing strength in tonnes (1,000 kg);
- c) FATO — type of FATO, true bearing to one-hundredth of a degree, designation number (where appropriate), length and width to the nearest metre or foot, slope, surface type;
- d) safety area — length, width and surface type;
- e) helicopter taxiway and helicopter taxi-route — designation, width, surface type;
- f) apron — surface type, helicopter stands;
- g) clearway — length, ground profile; and
- h) visual aids for approach procedures, marking and lighting of FATO, TLOF, helicopter taxiways, helicopter taxi routes and helicopter stands.

2.4.2 The geographical coordinates of the geometric centre of the TLOF and/or of each threshold of the FATO (where appropriate) shall be measured and reported to aeronautical information services in degrees, minutes, seconds and hundredths of seconds.

2.4.3 The geographical coordinates of appropriate centre line points of helicopter taxiways and helicopter taxi-routes shall be measured and reported to aeronautical information services in degrees, minutes, seconds and hundredths of seconds.

2.4.4 The geographical coordinates of each helicopter stand shall be measured and reported to aeronautical information services in degrees, minutes, seconds and hundredths of seconds.

2.4.5 The geographical coordinates of obstacles in Area 2 (the part within the heliport boundary) and in Area 3 shall be measured and reported to the aeronautical information services authority in degrees, minutes, seconds and tenths of seconds.

2.4.6 In addition, the top elevation, type, marking and lighting (if any) of obstacles shall be reported to aeronautical information services.

Note. — ICAO PANS-AIM (Doc 10066), Appendix 8, provides requirements for obstacle data determination in Areas 2 and 3.

2.5 Declared distances

2.5.1 The following distances to the nearest metre shall be declared, where relevant, for a heliport:

- a) take-off distance available;
- b) rejected take-off distance available; and

- c) landing distance available.

2.6 Coordination between aeronautical information services and heliport authorities

2.6.1 To ensure that aeronautical information services units obtain information to enable them to provide up-to-date pre-flight information and to meet the need for in-flight information, arrangements shall be made between aeronautical information services and heliport authorities responsible for heliport services to report to the responsible aeronautical information services unit, with a minimum of delay:

- a) information on heliport conditions;
- b) the operational status of associated facilities, services and navigation aids within their area of responsibility;
- c) any other information considered to be of operational significance.

2.6.2 Before introducing changes to the air navigation system, due account shall be taken by the services responsible for such changes of the time needed by the aeronautical information service for the preparation, production and issue of relevant material for promulgation. To ensure timely provision of the information to aeronautical information services, close coordination between those services concerned is therefore required.

2.6.3 Of a particular importance are changes to aeronautical information that affect charts and/or computer-based navigation systems which qualify to be notified by the aeronautical information regulation and control (AIRAC) system, as specified in CAD 15, Chapter 6. The predetermined, internationally agreed AIRAC effective dates shall be observed by the responsible heliport services when submitting the raw information/data to aeronautical information services.

Note. — Detailed specifications concerning the AIRAC system are contained in the ICAO PANS-AIM (Doc 10066), Chapter 6.

2.6.4 The heliport services responsible for the provision of raw aeronautical information/data to aeronautical information services shall do that while taking into account accuracy and integrity requirements necessary to meet the needs of the end-user of aeronautical data.

Note 1. — Specifications concerning the accuracy and integrity classification of heliport-related aeronautical data are contained in the ICAO PANS-AIM (Doc 10066), Appendix 1.

Note 2. — Specifications for the issue of a NOTAM are contained in CAD 15, Chapter 6 and the ICAO PANS-AIM (Doc 10066), Appendices 3 and 4, respectively.

Note 3. — AIRAC information is distributed by aeronautical information services at least 42 days in advance of the AIRAC effective dates with the objective of reaching recipients at least 28 days in advance of the effective date.



Note 4. — The schedule of the predetermined internationally agreed AIRAC common effective dates at intervals of 28 days and guidance for AIRAC use are contained in the Aeronautical Information ICAO Services Manual (Doc 8126, Chapter 2).

2.7 Rescue and firefighting

Note. — See 6.2 for information on rescue and firefighting services.

2.7.1 Information concerning the level of protection provided at a heliport for helicopter rescue and firefighting purposes shall be made available.

2.7.2 The level of protection normally available at a heliport shall be expressed in terms of the category of the rescue and firefighting service as described in 6.2 and in accordance with the types and amounts of extinguishing agents normally available at the heliport.

2.7.3 Changes in the level of protection normally available at a heliport for rescue and firefighting shall be notified to the appropriate aeronautical information services units and, where applicable, air traffic units to enable them to provide the necessary information to arriving and departing helicopters. When such a change has been corrected, the above units shall be advised accordingly.

Note. — Changes in the level of protection from that normally available at the heliport could result from, but may not be limited to, a change in the availability of extinguishing agent or equipment used to deliver agents, or of personnel used to operate the equipment.

2.7.4 A change shall be expressed in terms of the new category of the rescue and firefighting service available at the heliport.

3 Physical Characteristics

3.1 Onshore heliports

Note 1. — The provisions given in this section are based on the design assumption that no more than one helicopter will be in the FATO at the same time.

Note 2. — The design provisions given in this section assume when conducting operations to a FATO in proximity to another FATO, these operations will not be simultaneous. If simultaneous helicopter operations are required, appropriate separation distances between FATOs need to be determined, giving due regard to such issues as rotor downwash and airspace, and ensuring the flight paths for each FATO, defined in Chapter 4, do not overlap. Further guidance on this issue is given in the ICAO Heliport Manual (Doc 9261).

Note 3. — The provisions given in this section are common for surface-level heliports and elevated heliports unless otherwise specified.

Note 4. — Guidance on the minimum size for elevated FATO/TLOF in order to permit facilitation of essential operations around the helicopter is given in the ICAO Heliport Manual (Doc 9261).

Note 5. — Guidance on structural design to account for the presence on elevated heliports of personnel, freight, and refuelling and firefighting equipment, etc. is given in the ICAO Heliport Manual (Doc 9261).

Note 6. — Guidance on siting of a heliport and the location of the various defined areas, with due consideration of the effects of rotor downwash and other aspects of helicopter operations on third parties, is given in the ICAO Heliport Manual (Doc 9261).

Final approach and take-off area (FATO)

Note. — Guidance on siting and orientation of the FATO at a heliport to minimise interference of arrival and departure tracks with areas approved for residential use and other noise-sensitive areas close to the heliport is given in the ICAO Heliport Manual (Doc 9261).

3.1.1 A FATO shall:

a) provide:

- 1) an area free of obstacles, except for essential objects which because of their function are located on it, and of sufficient size and shape to ensure containment of every part of the design helicopter in the final phase of approach and commencement of take-off in accordance with the intended procedures;

Note. — Essential objects are visual aids (e.g. lighting) or others (e.g. firefighting systems) necessary for safety purposes. For further requirements regarding penetration of a FATO by essential objects, see 3.1.4.

- 2) when solid, a surface which is resistant to the effects of rotor downwash; and
 - i) when collocated with a TLOF, is contiguous and flush with the TLOF, has bearing strength capable of withstanding the intended loads and ensures effective drainage; or
 - ii) when not collocated with a TLOF, is free of hazards shall a forced landing be required;

Note. — *Resistant implies that effects from rotor downwash neither cause a degradation of the surface nor result in flying debris.*

and

- b) be associated with a safety area

3.1.2 A heliport shall be provided with at least one FATO, which need not be solid.

Note. — *A FATO may be located on or near a runway strip or taxiway strip.*

3.1.3 The minimum dimensions of a FATO shall be:

- a) where intended to be used by helicopters operated in performance class 1:
 - 1) the length of the rejected take-off distance (RTOD) for the required take-off procedure prescribed in the helicopter flight manual (HFM) of the helicopters for which the FATO is intended, or 1.5 Design D, whichever is greater; and
 - 2) the width for the required procedure prescribed in the HFM of the helicopters for which the FATO is intended, or 1.5 Design D, whichever is greater;

and

- b) where intended to be used by helicopters operated in performance class 2 or 3, the lesser of:
 - 1) an area within which can be drawn a circle of diameter of 1.5 Design D; or
 - 2) when there is a limitation on the direction of approach and touchdown, an area of sufficient width to meet the requirement of 3.1.1 a) 1) but not less than 1.5 times the overall width of the design helicopter.

Note 1. — *The RTOD is intended to ensure containment of the helicopter during a rejected take-off. Although some HFMs provide the RTOD, in others the dimension provided is the “minimum demonstrated ... size” (where “...” could be “heliport”, “runway”, “helideck”, etc.) and this may not include helicopter containment. When this is the case, it is necessary to consider sufficient safety area dimensions as well as the dimensions of 1.5·D for the FATO, shall the HFM not deliver data. For further guidance see the ICAO Heliport Manual (Doc 9261).*

Note 2. — *Local conditions, such as elevation, temperature and permitted manoeuvring may need to be considered when determining the size of a FATO. Guidance is given in the ICAO Heliport Manual (Doc 9261).*

- 3.1.4 Essential objects located in a FATO shall not penetrate a horizontal plane at the FATO elevation by more than 5 cm.
- 3.1.5 When the FATO is solid, the slope shall not:
- a) except as provided in b) or c) below, exceed 2 per cent in any direction;
 - b) when the FATO is elongated and intended to be used by helicopters operated in performance class 1, exceed 3 percent overall, or have a local slope exceeding 5 per cent; and
 - c) when the FATO is elongated and intended to be used solely by helicopters operated in performance class 2 or 3, exceed 3 per cent overall, or have a local slope exceeding 7 per cent.
- 3.1.6 As far as practicable, the FATO shall be located so as to minimise the influence of the surrounding environment, including turbulence, which could have an adverse impact on helicopter operations.
- Note. — Guidance on determining the influence of turbulence is given in the ICAO Heliport Manual (Doc 9261). If turbulence mitigating design measures are warranted but not practical, operational limitations may need to be considered under certain wind conditions.*
- 3.1.7 A FATO shall be surrounded by a safety area which need not be solid.
- Safety areas**
- 3.1.8 A safety area shall provide:
- a) an area free of obstacles, except for essential objects which because of their function are located on it, to compensate for manoeuvring errors; and
 - b) when solid, a surface which is contiguous and flush with the FATO, is resistant to the effects of rotor downwash and ensures effective drainage.
- 3.1.9 The safety area surrounding a FATO shall extend outwards from the periphery of the FATO for a distance of at least 3 m or 0.25 Design D, whichever is greater (see Figure 3-1).
- 3.1.10 No mobile object shall be permitted in a safety area during helicopter operations.
- 3.1.11 Essential objects located in the safety area shall not penetrate a surface originating at the edge of the FATO at a height of 25 cm above the plane of the FATO sloping upwards and outwards at a gradient of 5 per cent.
- 3.1.12 When solid, the slope of the safety area shall not exceed an upward slope of 4 per cent outwards from the edge of the FATO.

Safety area = at least 3m or 0.25 design D

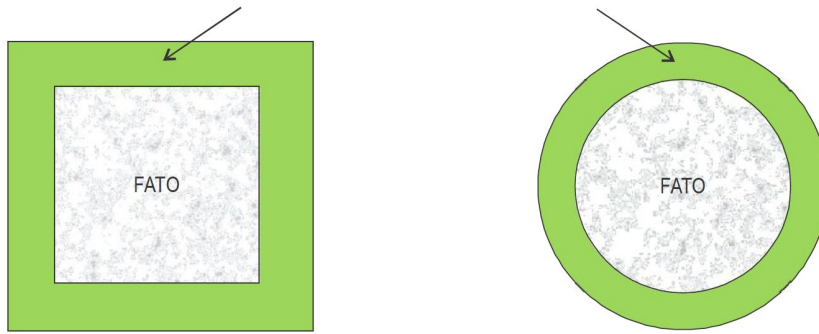

Figure 3-1. FATO and associated safety area

Protected side slope

- 3.1.13 A heliport shall be provided with at least one protected side slope, rising at 45 degrees from the edge of the safety area and extending to a distance of 10 m (see Figure 3-2).
- 3.1.14 *RESERVED*
- 3.1.15 The surface of a protected side slope shall not be penetrated by obstacles.

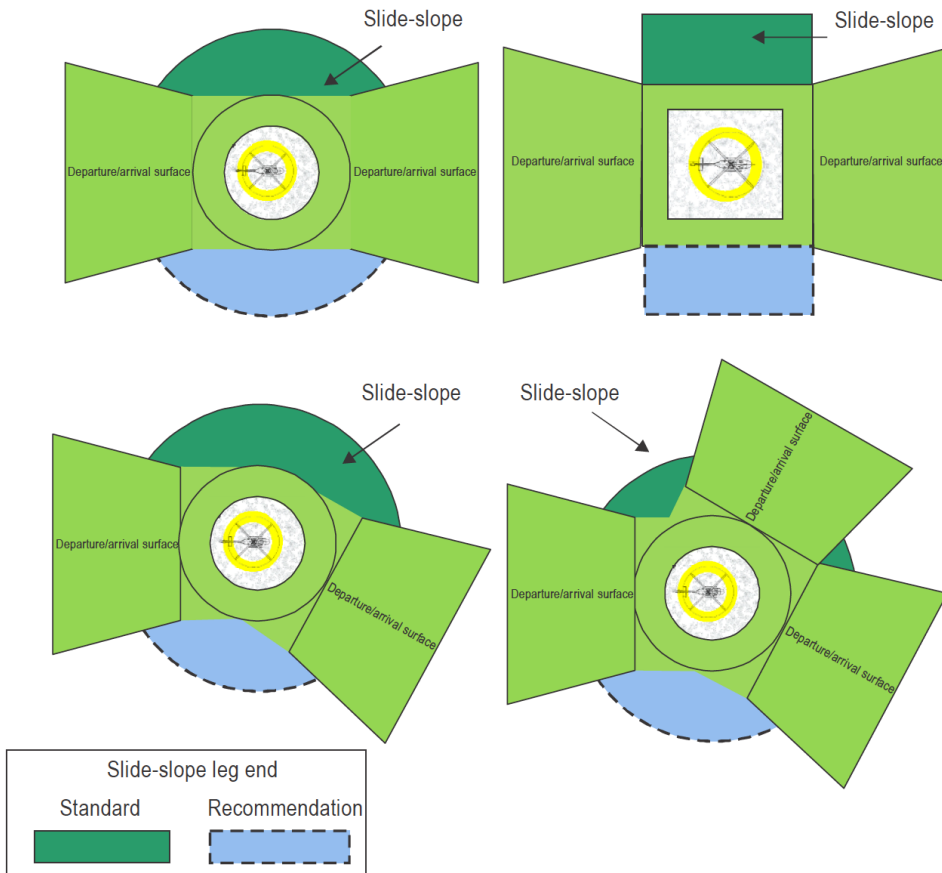

Figure 3-2. FATO simple/complex safety area and side slope protection

Note. — These diagrams show a number of configurations of FATO/safety areas/side slopes. For a more complex departure/arrival arrangement which consists of: two surfaces that are not diametrically opposed; more than two surfaces; or an extensive obstacle-free sector which abuts directly to the FATO, it can be seen that appropriate provisions are necessary to ensure that there are no obstacles between the FATO and/or safety area and the departure/arrival surfaces.

Helicopter clearways

Note. — The inclusion of detailed specifications for helicopter clearways in this section is not intended to imply that a clearway has to be provided.

- 3.1.16 A helicopter clearway shall provide:
- a) an area free of obstacles, except for essential objects which because of their function are located on it, and of sufficient size and shape to ensure containment of the design helicopter when it is accelerating in level flight, and close to the surface, to achieve its safe climbing speed; and
 - b) when solid, a surface which is contiguous and flush with the FATO, is resistant to the effects of rotor downwash and is free of hazards shall a forced landing be required.
- 3.1.17 When a helicopter clearway is provided, it shall be located beyond the end of the FATO.
- 3.1.18 The width of a helicopter clearway shall not be less than that of the FATO and associated safety area (see Figure 3-1).
- 3.1.19 When solid, the ground in a helicopter clearway shall not project above a plane having an overall upward slope of 3 per cent, or having a local upward slope exceeding 5 per cent, the lower limit of this plane being a horizontal line which is located on the periphery of the FATO.
- 3.1.20 An object situated in a helicopter clearway, which may endanger helicopters in the air, shall be regarded as an obstacle and shall be removed.

Touchdown and lift-off area (TLOF)

- 3.1.21 A TLOF shall:
- a) provide:
 - 1) an area free of obstacles and of sufficient size and shape to ensure containment of the undercarriage of the most demanding helicopter the TLOF is intended to serve in accordance with the intended orientation;
 - 2) a surface which:
 - i) has sufficient bearing strength to accommodate the dynamic loads associated with the anticipated type of arrival of the helicopter at the designated TLOF;

- ii) is free of irregularities that would adversely affect the touchdown or lift-off of helicopters;
- iii) has sufficient friction to avoid skidding of helicopters or slipping of persons; and
- iv) is resistant to the effects of rotor downwash;
- v) ensures effective drainage while having no adverse effect on the control or stability of a helicopter during touchdown and lift-off, or when stationary;

and

- b) be associated with a FATO or a stand.

3.1.22 A heliport shall be provided with at least one TLOF.

3.1.23 A TLOF shall be provided whenever it is intended that the undercarriage of the helicopter will touch down within a FATO or stand, or lift off from a FATO or stand.

3.1.24 The minimum dimensions of a TLOF shall be:

- a) when in a FATO intended to be used by helicopters operated in performance class 1, the dimensions for the required procedure prescribed in the HFMs of the helicopters for which the TLOF is intended; and

- b) when in a FATO intended to be used by helicopters operated in performance class 2 or 3, or in a stand:

- 1) when there is no limitation on the direction of touchdown, of sufficient size to contain a circle of diameter of at least 0.83D of:

- i) in a FATO, the design helicopter; or
- ii) in a stand, the largest helicopter the stand is intended to serve;

and

- 2) when there is a limitation on the direction of touchdown, of sufficient width to meet the requirement of 3.1.21 a) 1) but not less than twice the undercarriage width (UCW) of:

- i) in a FATO, the design helicopter; or
- ii) in a stand, the most demanding helicopter the stand is intended to serve.

3.1.25 For an elevated heliport, the minimum dimensions of a TLOF, when in a FATO, shall be of sufficient size to contain a circle of diameter of at least 1 Design D.

3.1.26 The slope on a TLOF shall not:

- a) except as provided in b) or c) below, exceed 2 per cent in any direction;
- b) when the TLOF is elongated and intended to be used by helicopters operated in performance class 1, exceed 3 percent overall, or have a local slope exceeding 5 per cent; and

- c) when the TLOF is elongated and intended to be used solely by helicopters operated in performance class 2 or 3, exceed 3 per cent overall, or have a local slope exceeding 7 per cent.
- 3.1.27 When a TLOF is within a FATO, it shall be:
- a) centred on the FATO; or
- b) for an elongated FATO, centred on the longitudinal axis of the FATO.
- 3.1.28 When a TLOF is within a helicopter stand, it shall be centred on the stand.
- 3.1.29 A TLOF shall be provided with markings which clearly indicate the touchdown position and, by their form, any limitations on manoeuvring.
- Note. — When a TLOF in a FATO is larger than the minimum dimensions, the touchdown/positioning marking (TDPM) may be offset while ensuring containment of the undercarriage within the TLOF and the helicopter within the FATO.*
- 3.1.30 Where an elongated performance class 1 FATO/TLOF contains more than one TDPM, measures shall be in place to ensure that only one can be used at a time.
- 3.1.31 Where alternative TDPMs are provided, they shall be placed to ensure containment of the undercarriage within the TLOF and the helicopter within the FATO.
- Note. — The efficacy of the rejected take-off or landing distance will be dependent upon the helicopter being correctly positioned for take-off or landing.*
- 3.1.32 Safety devices such as safety nets or safety shelves shall be located around the edge of an elevated heliport but shall not exceed the height of the TLOF.

Helicopter taxiways and taxi-routes

Note 1. — The specifications for ground taxi-routes and air taxi-routes are intended for the safety of simultaneous operations during the manoeuvring of helicopters. The effect of wind velocity/turbulence induced by rotor downwash would need to be considered.

Note 2. — The defined areas addressed in this section are:

- a) taxiways associated with air taxi-routes which may be used by both wheeled and skidded helicopters for either ground or air taxiing;
- b) ground taxi-routes which are meant for use by wheeled helicopters for ground taxiing only; and
- c) air taxi-routes which are meant for use by air taxiing only.

Helicopter taxiways

Note 1. — A helicopter taxiway is intended to permit the surface movement of a wheeled helicopter under its own power.

Note 2. — A helicopter taxiway may be used by a wheeled helicopter for air taxi if associated with a helicopter air taxi - route.

Note 3. — When a taxiway is intended for use by aeroplanes and helicopters, the provisions for aeroplane taxiways, taxiway strips, helicopter taxiways and taxi-routes will be taken into consideration and the more stringent requirements will be applied.

3.1.33 A helicopter taxiway shall:

a) provide:

- 1) an area free of obstacles and of sufficient width to ensure containment of the undercarriage of the most demanding wheeled helicopter the taxiway is intended to serve;
- 2) a surface which:
 - i) has bearing strength to accommodate the taxiing loads of the helicopters the taxiway is intended to serve;
 - ii) is free of irregularities that would adversely affect the ground taxiing of helicopters; and
 - iii) is resistant to the effects of rotor downwash;
 - iv) ensures effective drainage while having no adverse effect on the control or stability of a wheeled helicopter when being manoeuvred under its own power, or when stationary;

and

b) be associated with a taxi-route.

3.1.34 The minimum width of a helicopter taxiway shall be the lesser of:

- a) twice the UCW of the most demanding helicopter the taxiway is intended to serve; or
- b) a width meeting the requirements of 3.1.33 a) 1).

3.1.35 The transverse slope of a taxiway shall not exceed 2 per cent and the longitudinal slope shall not exceed 3 per cent.

Helicopter taxi-routes

3.1.36 A helicopter taxi-route shall provide:

- a) an area free of obstacles, except for essential objects which because of their function are located on it, established for the movement of helicopters; of sufficient width to ensure containment of the largest helicopter the taxi-route is intended to serve; and
- b) when solid, a surface which is resistant to the effects of rotor downwash; and
 - 1) when collocated with a taxiway:
 - i) is contiguous and flush with the taxiway;
 - ii) does not present a hazard to operations; and
 - iii) ensures effective drainage; and

- 2) when not collocated with a taxiway, is free of hazards shall a forced landing be required.

3.1.37 No mobile object shall be permitted on a taxi-route during helicopter operations.

Note. — See the ICAO Heliport Manual (Doc 9261) for further guidance.

3.1.38 When solid and collocated with a taxiway, the taxi-route shall not exceed an upward transverse slope of 4 per cent outwards from the edge of the taxiway.

Helicopter ground taxi-routes

3.1.39 A helicopter ground taxi-route shall have a minimum width of 1.5 times the overall width of the largest helicopter it is intended to serve, and be centred on a taxiway. (See Figure 3-3.)

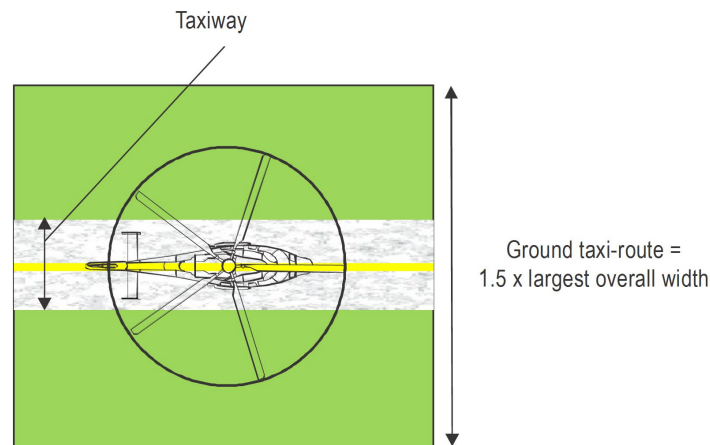

Figure 3-3. Helicopter taxiway/ground taxi-route

3.1.40 Essential objects located in a helicopter ground taxi-route shall not:

- a) be located at a distance of less than 50 cm outwards from the edge of the helicopter taxiway; and
- b) penetrate a surface originating 50 cm outwards of the edge of the helicopter taxiway and a height of 25 cm above the surface of the taxiway and sloping upwards and outwards at a gradient of 5 per cent.

Helicopter air taxi-routes

Note. — A helicopter air-taxi route is intended to permit the movement of a helicopter above the surface at a height normally associated with ground effect and at ground speed less than 37 km/h (20 kt).

3.1.41 A helicopter air taxi-route shall have a minimum width of twice the overall width of the largest helicopter it is intended to serve.

3.1.42 If collocated with a taxiway for the purpose of permitting both ground and air taxi operations (see Figure 3-4):

- a) the helicopter air taxi-route shall be centred on the taxiway; and
- b) essential objects located in the helicopter air taxi-route shall not:
 - 1) be located at a distance of less than 50 cm outwards from the edge of the helicopter taxiway; and
 - 2) penetrate a surface originating 50 cm outwards of the edge of the helicopter taxiway and a height of 25 cm above the surface of the taxiway and sloping upwards and outwards at a gradient of 5 per cent.

3.1.43 When not collocated with a taxiway, the slopes of the surface of an air taxi-route shall not exceed the slope landing limitations of the helicopters the taxi-route is intended to serve. In any event, the transverse slope shall not exceed 10 per cent and the longitudinal slope shall not exceed 7 per cent.

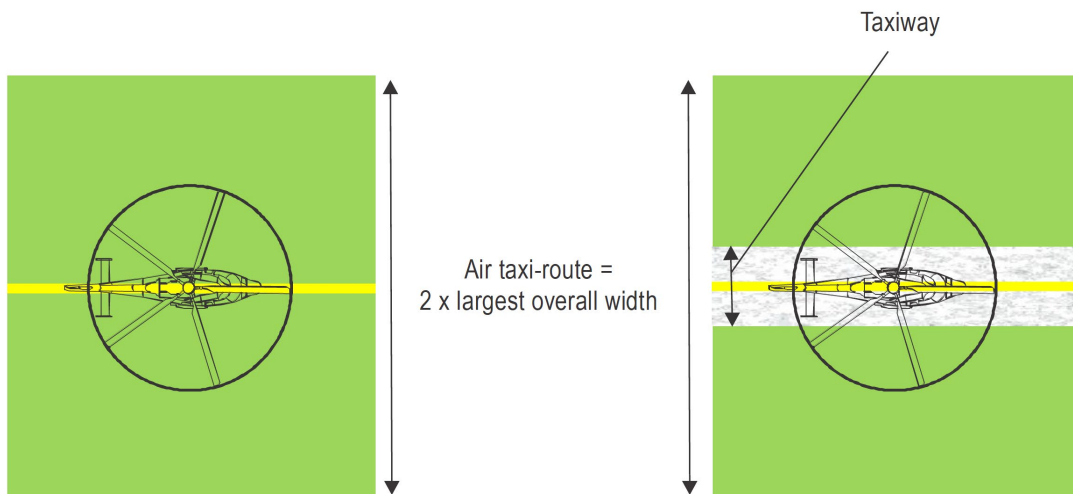

Figure 3-4. Helicopter air taxi -route and combined air taxi-route/taxiway

Helicopter stands

Note. — The provisions of this section do not specify the location for helicopter stands but allow a high degree of flexibility in the overall design of the heliport. However, it is not considered good practice to locate helicopter stands under a flight path. See the ICAO Heliport Manual (Doc 9261) for further guidance.

- 3.1.44 A helicopter stand shall:
- a) provide:
 - 1) an area free of obstacles and of sufficient size and shape to ensure containment of every part of the largest helicopter the stand is intended to serve when it is being positioned within the stand;
 - 2) a surface which:
 - i) is resistant to the effects of rotor downwash;
 - ii) is free of irregularities that would adversely affect the manoeuvring of helicopters;
 - iii) has bearing strength capable of withstanding the intended loads;

- iv) has sufficient friction to avoid skidding of helicopters or slipping of persons; and
- v) ensures effective drainage while having no adverse effect on the control or stability of a wheeled helicopter when being manoeuvred under its own power, or when stationary;

and

- b) be associated with a protection area.

3.1.45 The minimum dimensions of a helicopter stand shall be:

- a) a circle of diameter of 1.2D of the largest helicopter the stand is intended to serve; or
- b) when there is a limitation on manoeuvring and positioning, of sufficient width to meet the requirement of 3.1.44 a) 1) but not less 1.2 times overall width of largest helicopter the stand is intended to serve.

Note 1. — For a helicopter stand intended to be used for taxi-through only, a width less than 1.2D but which provides containment and still permits all required functions of a stand to be performed, might be used (in accordance with 3.1.44 a) 1)).

Note 2. — For a helicopter stand intended to be used for turning on the ground, the minimum dimensions may be influenced by the turning circle data provided by the manufacturer and are likely to exceed 1.2D. See the ICAO Heliport Manual (Doc 9261) for further guidance.

3.1.46 The mean slope of a helicopter stand in any direction shall not exceed 2 per cent.

3.1.47 Each helicopter stand shall be provided with positioning markings to clearly indicate where the helicopter is to be positioned and, by their form, any limitations on manoeuvring.

3.1.48 A stand shall be surrounded by a protection area which need not be solid.

Protection areas

3.1.49 Protection area shall provide:

- a) an area free of obstacles, except for essential objects which because of their function are located on it; and
- b) when solid, a surface which is contiguous and flush with the stand, is resistant to the effects of rotor downwash and ensures effective drainage.

3.1.50 When associated with a stand designed for turning, the protection area shall extend outwards from the periphery of the stand for a distance of 0.4D (see Figure 3.5).

- 3.1.51 When associated with a stand designed for taxi-through, the minimum width of the stand and protection area shall not be less than the width of the associated taxi-route (see Figures 3.6 and 3.7).
- 3.1.52 When associated with a stand designed for non-simultaneous use (see Figures 3.8 and 3.9):
- the protection area of adjacent stands may overlap but shall not be less than the required protection area for the larger of the adjacent stands; and
 - the adjacent non-active stand may contain a static object but it shall be wholly within the boundary of the stand.
- Note. — To ensure that only one of the adjacent stands is active at a time, instruction to pilots in the AIP make clear that a limitation on the use of the stands is in force.*
- 3.1.53 No mobile object shall be permitted in a protection area during helicopter operations.
- 3.1.54 Essential objects located in the protection area shall not:
- if located at a distance of less than $0.75D$ from the centre of the helicopter stand, penetrate a surface at a height of 5 cm above the surface of the central zone; and
 - if located at a distance of $0.75D$ or more from the centre of the helicopter stand, penetrate a surface at a height of 25 cm above the plane of the central zone and sloping upwards and outwards at a gradient of 5 per cent.
- 3.1.55 When solid, the slope of a protection area shall not exceed an upward slope of 4 percent outwards from the edge of the stand.

Location of a FATO in relation to a runway or taxiway

- 3.1.56 Where a FATO is located near a runway or taxiway, and where simultaneous operations are planned, the separation distance between the edge of a runway or taxiway and the edge of a FATO shall not be less than the appropriate dimension in Table 3-1.
- 3.1.57 A FATO shall not be located:
- near taxiway intersections or holding points where jet engine efflux is likely to cause high turbulence; or
 - near areas where aeroplane vortex wake generation is likely to exist.

Table 3-1. FATO minimum separation distance for simultaneous operations

If aeroplane mass and/or helicopter mass are	Distance between FATO edge and runway edge or taxiway edge
up to but not including 3,175 kg	60 m
3,175 kg up to but not including 5,760 kg	120 m
5,760 kg up to but not including 100,000 kg	180 m
100,000 kg and over	250 m

Table 3-1. FATO minimum separation distance for simultaneous operations

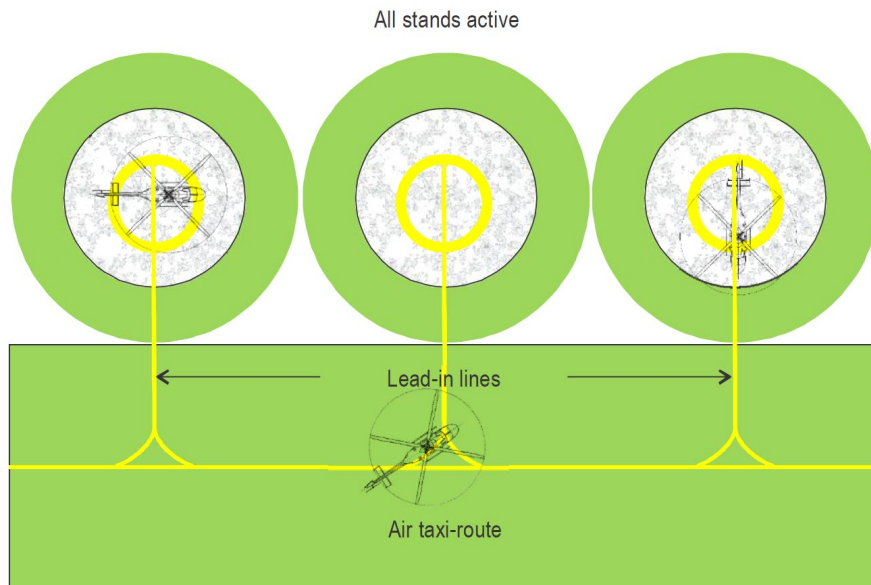

Figure 3-5. Turning stands (with air taxi-routes) — simultaneous use

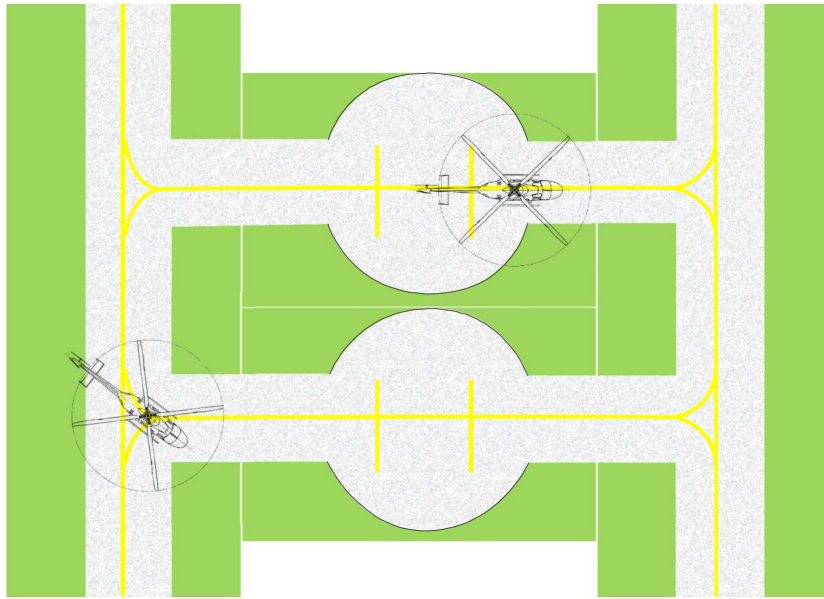

Figure 3-6. Ground taxi-through stands (with taxiway/ground taxi -route) simultaneous use

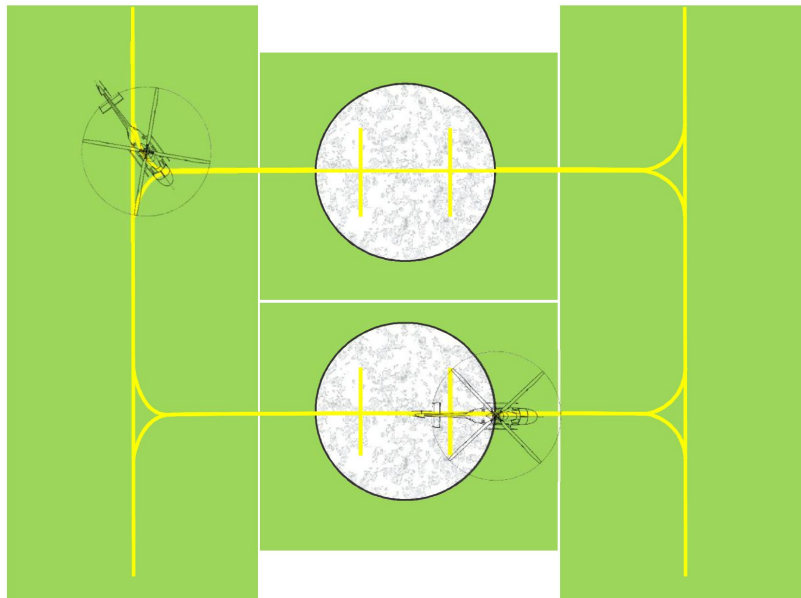

Figure 3-7. Air taxi-through stands (with air taxi -route) simultaneous use

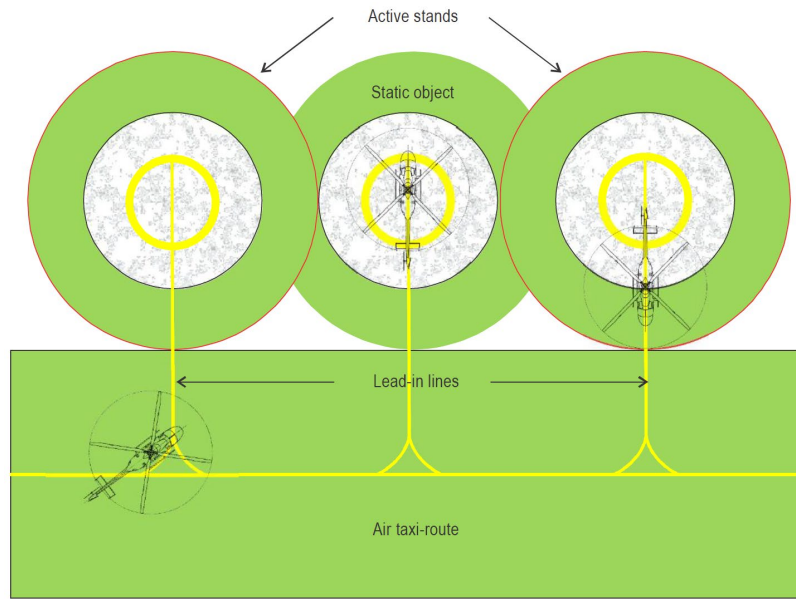

Figure 3-8. Turning stands (with air taxi -routes) non-simultaneous use — outer stands active

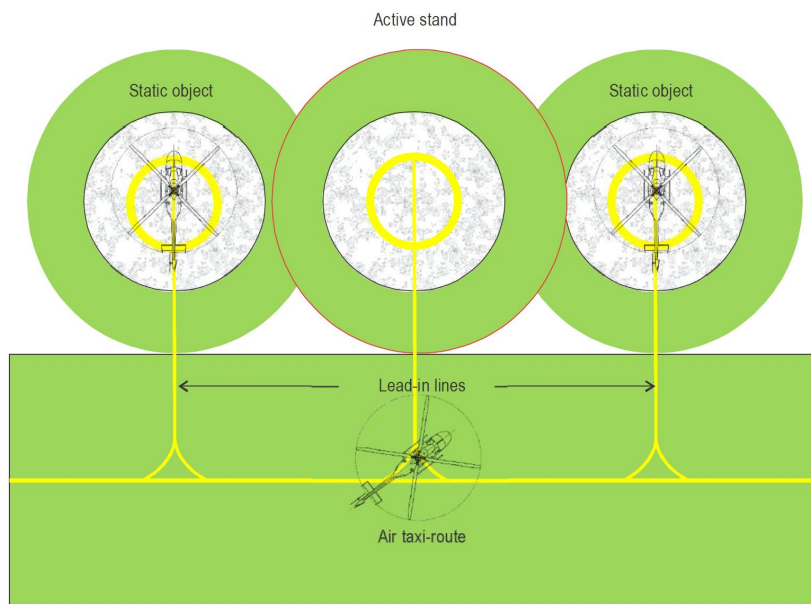

Figure 3-9. Turning stands (with air taxi-route) non-simultaneous use — inner stand active

3.2 Helidecks

Note. — The following specifications are for helidecks located on structures engaged in such activities as mineral exploitation, research or construction. See 3.3 for shipboard heliport provisions.

FATOs and TLOFs

Note 1. — For helidecks that have a 1D or larger FATO it is presumed that the FATO and the TLOF will always occupy the same space and have the same load bearing characteristics so as to be coincidental. For helidecks that are less than 1D, the reduction in size is only applied to the TLOF which is a load bearing area. In this case, the FATO remains at 1D but the portion extending beyond the TLOF perimeter need not be load bearing for helicopters. The TLOF and the FATO may be assumed to be collocated.

Note 2.— Guidance on the effects of airflow direction and turbulence, prevailing wind velocity and high temperatures from gas turbine exhausts or flare-radiated heat on the location of the FATO is given in the Heliport Manual (Doc 9261).

Note 3.— Guidance on the design and markings for helideck parking areas is given in the Heliport Manual (Doc 9261).

3.2.1 *The specifications in paragraphs 3.3.14 and 3.3.15 shall be applicable for helidecks completed on or after 1 January 2021.*

3.2.2 A helideck shall be provided with one FATO and one coincident or collocated TLOF.

3.2.3 A FATO may be any shape but shall be of sufficient size to contain an area within which can be accommodated a circle of diameter of not less than 1D of the largest helicopter the helideck is intended to serve.

3.2.4 A TLOF may be any shape but shall be of sufficient size to contain:

- a) for helicopters with an MTOM of more than 3 175 kg, an area within which can be accommodated a circle of diameter not less than 1D of the largest helicopter the helideck is intended to serve; and
- b) for helicopters with an MTOM of 3 175 kg or less, an area within which can be accommodated a circle of diameter not less than 0.83D of the largest helicopter the helideck is intended to serve.

3.2.5 *RESERVED*

3.2.6 A helideck shall be arranged to ensure that a sufficient and unobstructed air-gap is provided which encompasses the full dimensions of the FATO.

Note. — Specific guidance on the characteristics of an air-gap is given in the ICAO Heliport Manual (Doc 9261). As a general rule, except for shallow superstructures of three stories or less, a sufficient air -gap will be at least 3 m.

3.2.7 FATO shall be located so as to avoid, as far as is practicable, the influence of environmental effects, including turbulence, over the FATO, which could have an adverse impact on helicopter operations.

3.2.8 The TLOF shall be dynamic load-bearing.

3.2.9 The TLOF shall provide ground effect.

- 3.2.10 No fixed object shall be permitted around the edge of the TLOF, except for essential objects whose function requires them to be located thereon,—that includes:
- a) Guttering or raised kerb;
 - b) Lightings;
 - c) Foam monitors;
 - d) Handrails;
 - e) Perimeter net edge;
 - f) Landing net tie-down points; and
 - g) Flame and gas detectors.

for new helidecks, tie down points shall be flushed.

Note. — Essential objects are visual aids or others necessary for safety purposes.

- 3.2.11 For any TLOF 1 D or greater and any TLOF designed for use by helicopters having a D-value of greater than 16.0 m, essential objects installed in the obstacle-free sector whose function requires them to be located on the edge of the TLOF shall not exceed a height of 25 cm.
- 3.2.12 For new built helidecks completed on or after 10th November 2018 and for refurbished helidecks, any TLOF 1 D or greater and any TLOF designed for use by helicopters having a D-value of greater than 16.0 m, essential objects installed in the obstacle-free sector whose function requires them to be located on the edge of the TLOF should be as low as possible and in any case not exceed a height of 15 cm.
- 3.2.13 For any TLOF having a D-value of 16.0 m or less, and any TLOF having dimensions of less than 1D, essential objects installed in the obstacle-free sector whose function requires them to be located on the edge of the TLOF, shall not exceed a height of 5 cm.

Note. — Lighting that is mounted at a height of less than 25 cm is typically assessed for adequacy of visual cues before and after installation.

- 3.2.14 Objects whose function requires them to be located within the TLOF, such as lighting or landing nets, shall not exceed a height of 2.5 cm. Such objects shall only be present if they do not represent a hazard to helicopters.

Note. — Examples of potential hazards include nets or raised fittings on the deck that might induce dynamic rollover for helicopters equipped with skids.

- 3.2.15 Safety devices such as safety nets or safety shelves shall be located around the edge of a helideck but shall not exceed the height of TLOF.

- 3.2.16 The surface of the TLOF shall be skid-resistant to both helicopters and persons and be sloped to prevent pooling of water.

Note. — *Guidance on rendering the surface of the TLOF skid-resistant is contained in the ICAO Heliport Manual (Doc 9261).*

3.3 Shipboard heliports

- 3.3.1 The specifications in paragraphs 3.3.16 and 3.3.17 shall be applicable to shipboard heliports completed on or after 1 January 2012 and 1 January 2015, respectively.

- 3.3.2 When helicopter operating areas are provided in the bow or stern of a ship or are purpose-built above the ship's structure, they shall be regarded as purpose-built shipboard heliports.

FATOs and TLOFs

Note. — *Except for the arrangement described in 3.3.8 b), for shipboard heliports it is presumed that the FATO and the TLOF will be coincidental. Guidance on the effects of airflow direction and turbulence, prevailing wind velocity and high temperature from gas turbine exhausts or flare-radiated heat on the location of the FATO is given in the ICAO Heliport Manual (Doc 9261).*

- 3.3.3 A shipboard heliport shall be provided with one FATO and one coincidental or collocated TLOF.
- 3.3.4 A FATO may be any shape but shall be of sufficient size to contain an area within which can be accommodated a circle of diameter of not less than 1D of the largest helicopter the heliport is intended to serve.
- 3.3.5 The TLOF of a shipboard heliport shall be dynamic load-bearing.
- 3.3.6 The TLOF of a shipboard heliport shall provide ground effect.
- 3.3.7 For purpose-built shipboard heliports provided in a location other than the bow or stern, the TLOF shall be of sufficient size to contain a circle with a diameter not less than 1D of the largest helicopter the heliport is intended to serve.
- 3.3.8 For purpose-built shipboard heliports provided in the bow or stern of a ship, the TLOF shall be of sufficient size to:
- a) contain a circle with a diameter not less than 1D of the largest helicopter the heliport is intended to serve; or
 - b) for operations with limited touchdown directions, contain an area within which can be accommodated two opposing arcs of a circle with a diameter of not less than 1D in the helicopter's longitudinal direction. The minimum width of the heliport shall be not less than 0.83D. (See Figure 3-11.)

Note 1. — The ship will need to be manoeuvred to ensure that the relative wind is appropriate to the direction of the helicopter touchdown heading.

Note 2. — The touchdown heading of the helicopter is limited to the angular distance subtended by the 1D arc headings, minus the angular distance which corresponds to 15 degrees at each end of the arc.

- 3.3.9 For non-purpose-built shipboard heliports, the TLOF shall be of sufficient size to contain a circle with a diameter not less than 1D of the largest helicopter the heliport is intended to serve.
- 3.3.10 A shipboard heliport shall be arranged to ensure that a sufficient and unobstructed air -gap is provided which encompasses the full dimensions of the FATO.
- Note 1. — Specific guidance on the characteristics of an air-gap is given in the ICAO Heliport Manual (Doc 9261). As a general rule, except for shallow superstructures of three stories or less, a sufficient air-gap will be at least 3 m.*
- 3.3.11 The FATO should be located so as to avoid, as far as is practicable, the influence of environmental effects, including turbulence, over the FATO, which could have an adverse impact on helicopter operations.
- 3.3.12 No fixed object shall be permitted around the edge of the TLOF, except for frangible objects whose function requires them to be located thereon.
- 3.3.13 For any TLOF 1D or greater and any TLOF designed for use by helicopters having a D-value of greater than 16.0 m, objects installed in the obstacle-free sector whose function requires them to be located on the edge of the TLOF shall not exceed a height of 25 cm.
- 3.3.14 Any TLOF 1D or greater and any TLOF designed for use by helicopters having a D-value of greater than 16.0 m, essential objects installed in the obstacle-free sector whose function requires them to be located on the edge of TLOF shall not exceed a height of 15 cm.
- 3.3.15 Any TLOF designed for use by helicopters having a D-value of 16.0 m or less, objects installed in the obstacle-free sector whose function requires them to be located on the edge of the TLOF, shall not exceed a height of 5 cm.
- Note. — Lighting that is mounted at a height of less than 25 cm is typically assessed for adequacy of visual cues before and after installation.*
- 3.3.16 Objects whose function requires them to be located within the TLOF (such as lighting or nets) shall not exceed a height of 2.5 cm. Such objects shall only be present if they do not represent a hazard to helicopters.
- 3.3.17 Safety devices such as safety nets or safety shelves shall be located around the edge of a shipboard heliport, except where structural protection exists, but shall not exceed the height of TLOF.

3.3.18 The surface of the TLOF shall be skid-resistant to both helicopters and persons.

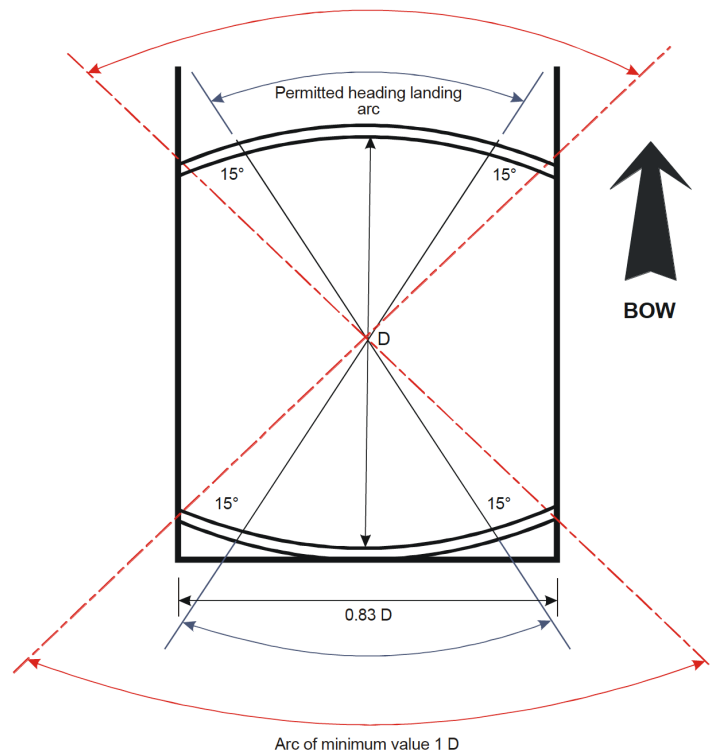

Figure 3-11. Shipboard permitted landing headings for limited heading operations

4 Obstacle Environment

Note. — The objectives of the specifications in this chapter are to describe the airspace around heliports so as to permit intended helicopter operations to be conducted safely and to prevent, where appropriate, heliports from becoming unusable by the growth of obstacles around them. This is achieved by establishing a series of obstacle limitation surfaces that define the limits to which objects may project into the airspace.

4.1 Obstacle limitation surfaces and sectors

Approach surface

4.1.1 Description. An inclined plane or a combination of planes or, when a turn is involved, a complex surface sloping upwards from the end of the safety area and centred on a line passing through the centre of the FATO.

Note. — See Table 4-1 for dimensions and slopes of surfaces. See Figures 4-1, 4-2, 4-3 and 4-4 for depiction of surfaces.

4.1.2 Characteristics. The limits of an approach surface shall comprise:

- a) an inner edge horizontal and equal in length to the minimum specified width/diameter of the FATO plus the safety area, perpendicular to the centre line of the approach surface and located at the outer edge of the safety area;
- b) two side edges originating at the ends of the inner edge diverging uniformly at a specified rate from the vertical plane containing the centre line of the FATO; and:
- c) an outer edge horizontal and perpendicular to the centre line of the approach surface and at a specified height of 152 m (500 ft.) above the elevation of the FATO.

4.1.3 The elevation of the inner edge shall be the elevation of the FATO at the point on the inner edge that is intersected by the centre line of the approach surface. For heliports intended to be used by helicopters operated in performance class 1 and when approved by the CAAM, the origin of the inclined plane may be raised directly above the FATO.

4.1.4 The slope(s) of the approach surface shall be measured in the vertical plane containing the centre line of the surface.

4.1.5 In the case of an approach surface involving a turn, the surface shall be a complex surface containing the horizontal normal to its centre line and the slope of the centre line shall be the same as that for a straight approach surface.

Note. — See Figure 4-5.

4.1.6 In the case of an approach surface involving a turn, the surface shall not contain more than one curved portion.

4.1.7 Where a curved portion of an approach surface is provided, the sum of the radius of arc defining the centre line of the approach surface and the length of the straight portion originating at the inner edge shall not be less than 575 m.

4.1.8 Any variation in the direction of the centre line of an approach surface shall be designed so as not to necessitate a turn radius less than 270 m.

Note. — For heliports intended to be used by helicopters operated in performance class 2 or 3, it is good practice for the approach paths to be selected so as to permit safe forced landings or one-engine-inoperative landings such that, as a minimum requirement, injury to persons on the ground or water or damage to property are minimised. The most critical helicopter type for which the heliport is intended and the ambient conditions may be factors in determining the suitability of such areas.

Transitional surface

Note. — For a FATO at a heliport without a PinS approach incorporating a visual segment surface (VSS) there is no requirement to provide transitional surfaces.

4.1.9 Description. A complex surface along the side of the safety area and part of the side of the approach/take-off climb surface, that slopes upwards and outwards to a predetermined height of 45 m (150 ft.).

Note. — See Figure 4-3. See Table 4-1 for dimensions and slopes of surfaces.

4.1.10 Characteristics. The limits of a transitional surface shall comprise:

- a) a lower edge beginning at a point on the side of the approach/take-off climb surface at a specified height above the lower edge extending down the side of the approach/take-off climb surface to the inner edge of the approach/takeoff climb surface and from there along the length of the side of the safety area parallel to the centre line of the FATO; and
- b) an upper edge located at a specified height above the lower edge as set out in Table 4-1.

4.1.11 The elevation of a point on the lower edge shall be:

- a) along the side of the approach/take-off climb surface — equal to the elevation of the approach/take-off climb surface at that point; and
- b) along the safety area — equal to the elevation of the inner edge of the approach/take-off climb surface.

Note 1. — If the origin of the inclined plane of the approach/take-off climb surface is raised as approved by the CAAM, the elevation of the origin of the transitional surface will be raised accordingly.

Note 2. — As a result of b), the transitional surface along the safety area will be curved if the profile of the FATO is curved, or a plane if the profile is a straight line.

- 4.1.12 The slope of the transitional surface shall be measured in a vertical plane at right angles to the centre line of the FATO.

Take-off climb surface

- 4.1.13 Description. An inclined plane, a combination of planes or, when a turn is involved, a complex surface sloping upwards from the end of the safety area and centred on a line passing through the centre of the FATO.

Note. — See Table 4-1 for dimensions and slopes of surfaces. See Figures 4-1, 4-2, 4-3 and 4-4 for depiction of surfaces.

- 4.1.14 Characteristics. The limits of a take-off climb surface shall comprise:
- a) an inner edge horizontal and equal in length to the minimum specified width/diameter of the FATO plus the safety area, perpendicular to the centre line of the take-off climb surface and located at the outer edge of the safety area;
 - b) two side edges originating at the ends of the inner edge and diverging uniformly at a specified rate from the vertical plane containing the centre line of the FATO; and
 - c) an outer edge horizontal and perpendicular to the centre line of the take-off climb surface and at a specified height of 152 m (500 ft.) above the elevation of the FATO.
- 4.1.15 The elevation of the inner edge shall be the elevation of the FATO at the point on the inner edge that is intersected by the centre line of the take-off climb surface. For heliports intended to be used by helicopters operated in performance class 1 and when approved by the CAAM, the origin of the inclined plane may be raised directly above the FATO.
- 4.1.16 Where a clearway is provided, the elevation of the inner edge of the take-off climb surface shall be located at the outer edge of the clearway at the highest point on the ground based on the centre line of the clearway.
- 4.1.17 In the case of a straight take-off climb surface, the slope shall be measured in the vertical plane containing the centre line of the surface.
- 4.1.18 In the case of a take-off climb surface involving a turn, the surface shall be a complex surface containing the horizontal normal to its centre line and the slope of the centre line shall be the same as that for a straight take-off climb surface.
- Note.* — See Figure 4-5.
- 4.1.19 In the case of a take-off climb surface involving a turn, the surface shall not contain more than one curved portion.

4.1.20 Where a curved portion of a take-off climb surface, is provided, the sum of the radius of arc defining the centre line of the take-off climb surface and the length of the straight portion originating at the inner edge shall not be less than 575 m.

4.1.21 Any variation in the direction of the centre line of a take-off climb surface shall be designed so as not to necessitate a turn of radius less than 270 m.

Note 1. — Helicopter take-off performance is reduced in a curve and as such a straight portion along the take-off climb surface prior to the start of the curve allows for acceleration.

Note 2. — For heliports intended to be used by helicopters operated in performance class 2 or 3, it is good practice for the departure paths to be selected so as to permit safe forced landings or one-engine-inoperative landings such that, as a minimum requirement, injury to persons on the ground or water or damage to property are minimised. The most critical helicopter type for which the heliport is intended and the ambient conditions may be factors in determining the suitability of such areas.

Obstacle-free sector/surface — Helidecks

4.1.22 Description. A complex surface originating at and extending from a reference point on the edge of the FATO of a helideck. In the case of a TLOF of less than 1 D, the reference point shall be located not less than 0.5 D from the centre of the TLOF.

4.1.23 Characteristics. An obstacle-free sector/surface shall subtend an arc of specified angle.

4.1.24 A helideck obstacle-free sector shall comprise of two components, one above and one below helideck level:

Note. — See Figure 4-7.

a) Above helideck level. The surface shall be a horizontal plane level with the elevation of the helideck surface that subtends an arc of at least 210 degrees with the apex located on the periphery of the D circle extending outwards to a distance that will allow for an unobstructed departure path appropriate to the helicopter the helideck is intended to serve.

b) Below helideck level. Within the (minimum) 210-degree arc, the surface shall additionally extend downward from the edge of the FATO below the elevation of the helideck to water level for an arc of not less than 180 degrees that passes through the centre of the FATO and outwards to a distance that will allow for safe clearance from the obstacles below the helideck in the event of an engine failure for the type of helicopter the helideck is intended to serve.

Note. — For both the above obstacle-free sectors for helicopters operated in performance class 1 or 2, the horizontal extent of these distances from the helideck will be compatible with the one-engine-inoperative capability of the helicopter type to be used.

Limited sector/surface — helidecks

Note. — Where obstacles are necessarily located on the structure, a helideck may have a limited obstacle sector (LOS).

- 4.1.25 Description. A complex surface originating at the reference point for the obstacle-free sector and extending over the arc not covered by the obstacle-free sector within which the height of obstacles above the level of the TLOF will be prescribed.
- 4.1.26 Characteristics. A limited obstacle sector shall not subtend an arc greater than 150 degrees. Its dimensions and location shall be as indicated in Figure 4-8 for a 1 D FATO with coincidental TLOF and Figure 4-9 for a 0.83 D TLOF.

4.2 Obstacle limitation requirements

Note 1. — The requirements for obstacle limitation surfaces are specified on the basis of the intended use of a FATO, i.e. approach manoeuvre to hover or landing, or take-off manoeuvre and type of approach, and are intended to be applied when such use is made of the FATO. In cases where operations are conducted to or from both directions of a FATO, then the function of certain surfaces may be nullified because of more stringent requirements of another lower surface.

Note 2. — Guidance on obstacle protection surfaces, for when a visual approach slope indicator (VASI) is installed, is given in the onshore section of the ICAO Helicopter Manual (Doc 9261).

Surface-level heliports

- 4.2.1 The following obstacle limitation surfaces shall be established for a FATO at heliports with a PinS approach procedure utilising a visual segment surface:
 - a) take-off climb surface;
 - b) approach surface; and
 - c) transitional surfaces.

Note 1. — See Figure 4-3.

Note 2. — The ICAO Procedures for Air Navigation Services — Aircraft Operations, (PANS-OPS, Doc 8168), Volume II, Part IV details procedure design criteria.

- 4.2.2 The following obstacle limitation surfaces shall be established for a FATO at heliports, other than specified in 4.2.1, including heliports with a PinS approach procedure where a visual segment surface is not provided:
 - a) take-off climb surface; and
 - b) approach surface.

- 4.2.3 The slopes of the obstacle limitation surfaces shall not be greater than, and their other dimensions not less than, those specified in Table 4-1 and shall be located as shown in Figures 4-1, 4-2 and 4-6.
- 4.2.4 For heliports that have an approach/take-off climb surface with a 4.5 per cent slope design, objects shall be permitted to penetrate the obstacle limitation surface if the results of an aeronautical study approved by the CAAM have reviewed the associated risks and mitigation measures.
- Note 1. — The identified objects may limit the heliport operation.*
- Note 2. — CAD 6, Part 3, provides procedures that may be useful in determining the extent of obstacle penetration.*
- 4.2.5 New objects or extensions of existing objects shall not be permitted above any of the surfaces in 4.2.1 and 4.2.2 except when shielded by an existing immovable object or after an aeronautical study approved by the CAAM determines that the object will not adversely affect the safety or significantly affect the regularity of operations of helicopters.
- Note. — Circumstances in which the shielding principle may reasonably be applied are described in the ICAO Airport Services ICAO Manual (Doc 9137), Part 6.*
- 4.2.6 Existing objects above any of the surfaces in 4.2.1 and 4.2.2 shall, as far as practicable, be removed except when the object is shielded by an existing immovable object or after an aeronautical study approved by the CAAM determines that the object will not adversely affect the safety or significantly affect the regularity of operations of helicopters.
- Note. — The application of curved approach or take-off climb surfaces as specified in 4.1.5 or 4.1.18 may alleviate the problems created by objects infringing these surfaces.*
- 4.2.7 A surface-level heliport shall have at least one approach and take-off climb surface. An aeronautical study shall be undertaken when only a single approach and take-off climb surface is provided considering as a minimum, the following factors:
- a) the area/terrain over which the flight is being conducted;
 - b) the obstacle environment surrounding the heliport and the availability of at least one protected side slope;
 - c) the performance and operating limitations of helicopters intending to use the heliport; and
 - d) the local meteorological conditions including the prevailing winds.
- Note. — See the ICAO Heliport Manual (Doc 9261) for guidance.*
- 4.2.8 **RESERVED**

Table 4-1. Dimensions and slopes of obstacle limitation surfaces for all visual FATOs

Surface and dimensions	Slope design categories		
	A	B	C
Approach and take-off climb surface			
Length of inner edge	Width of safety area	Width of safety area	Width of safety area
Location of inner edge	Safety area boundary (Clearway boundary if provided)	Safety area boundary	Safety area boundary
Divergence: (1st and 2nd section)			
Day use only	10%	10%	10%
Night use	15%	15%	15%
First Section:			
Length	3 386 m	245 m	1 220 m
Slope	4.5% (1:22.2)	8% (1:12.5)	12.5% (1:8)
Outer Width	(b)	N/A	(b)
Second Section:			
Length	N/A	830 m	N/A
Slope	N/A	16% (1:6.25)	N/A
Outer Width	N/A	(b)	N/A
Total Length from inner edge (a)	3 386 m	1 075 m	1 220 m
Transitional Surface: (FATOs with a Pins approach procedure with a VSS)			
Slope	50% (1:2)	50% (1:2)	50% (1:2)
Height	45 m	45 m	45 m
<p>a. The approach and take-off climb surface lengths of 3 386 m, 1 075 m and 1 220 m associated with the respective slopes brings the helicopter to 152 m (500 ft.) above FATO elevation.</p> <p>b. Seven rotor diameters overall width for day operations or 10 rotor diameters overall width for night operations.</p>			

Table 4-1. Dimensions and slopes of obstacle limitation surfaces for all visual FATOs

Note. — The slope design categories in Table 4-1 may not be restricted to a specific performance class of operation and may be applicable to more than one performance class of operation. The slope design categories depicted in Table 4-1 represent minimum design slope angles and not operational slopes. Slope category “A” generally corresponds with helicopters operated in performance class 1; slope category “B” generally corresponds with helicopters operated in performance class 3; and slope category “C” generally corresponds with helicopters operated in performance class 2. Consultation with helicopter operators will help to determine the appropriate slope category to apply according to the heliport environment and the most critical helicopter type for which the heliport is intended.

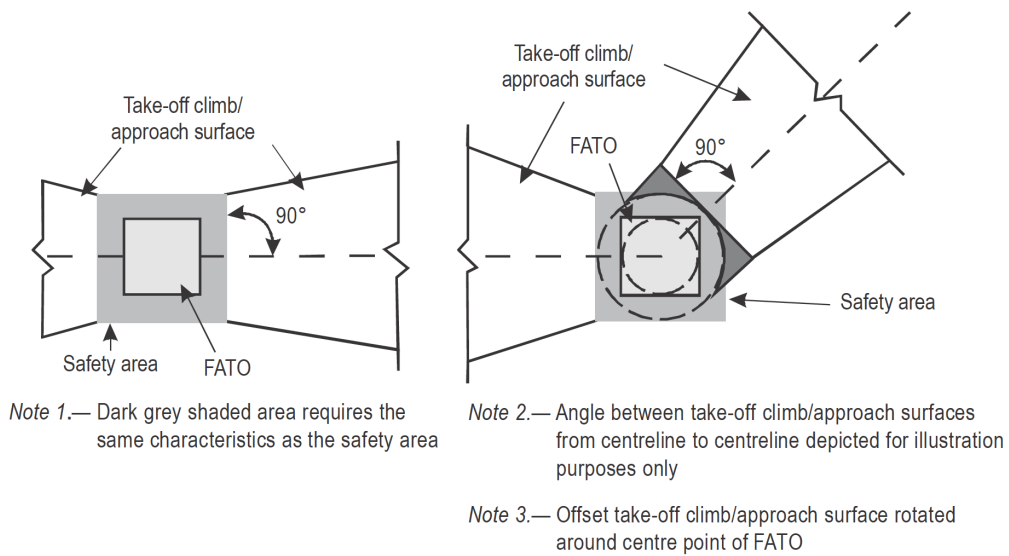

Figure 4-1. Obstacle limitation surfaces — take-off climb and approach surface

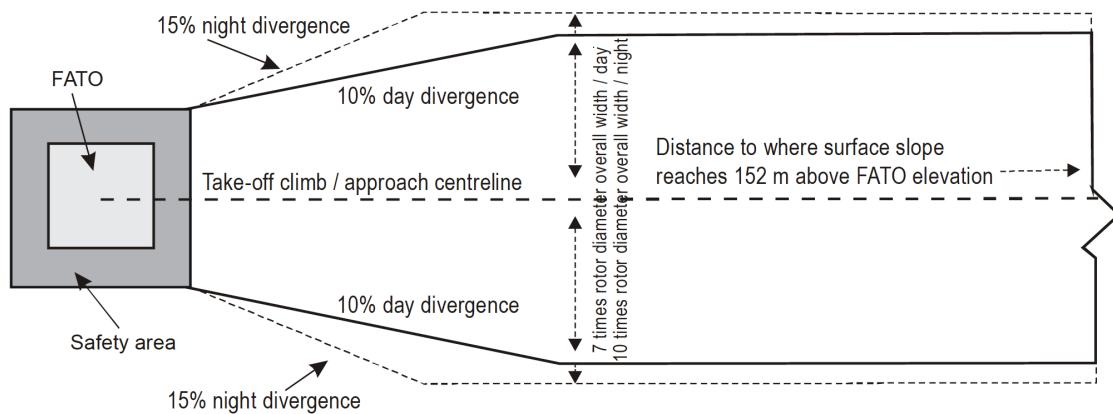
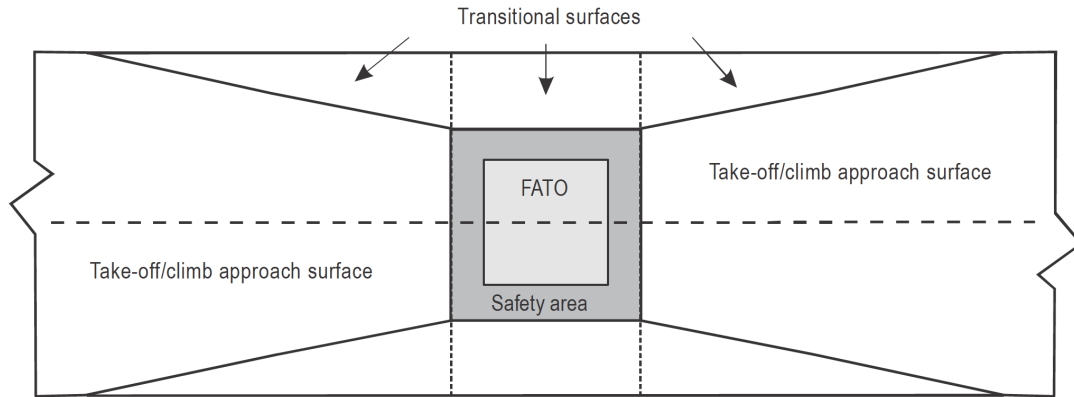
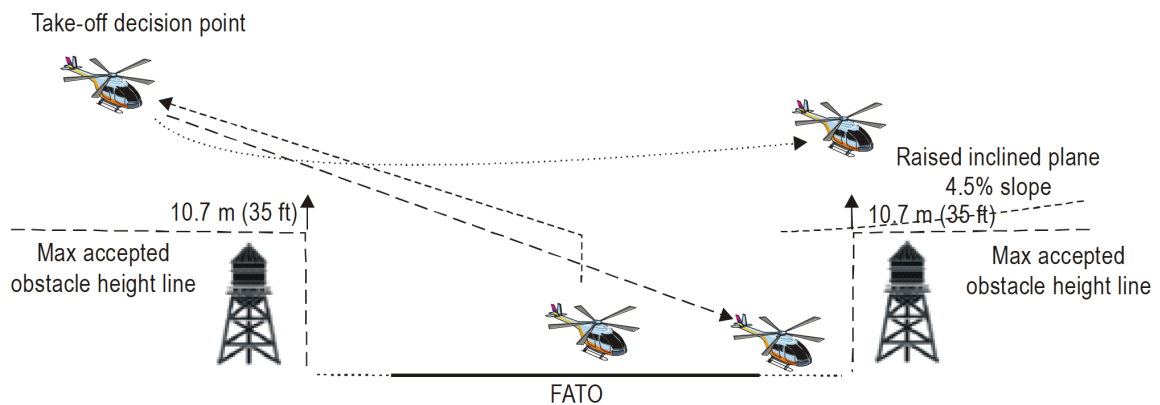

Figure 4-2. Take-off climb/approach surface width



Note 1.— For single take-off/climb approach surface. Transition surface extends to far side of safety area.
 Note 2.— PANS-OPS, Doc 8168, Volume II, Part IV, details procedure design criteria.
 Note 3.— This figure shows a square FATO for illustration purposes only. For a circular FATO, the transitional surface lower and upper edges would also be circular.

Figure 4-3. Transitional surface for a FATO with a Pins approach procedure with a VSS



LEGEND: - - - - Back-up procedure for departure as per Flight Manual
 Take-off profile or single-engine departure after take-off decision point
 - - - Approach or rejected take-off after engine failure at take-off decision point

Figure 4-4. Example of raised inclined plane during operations in performance class 1

Note 1. — This example diagram does not represent any specific profile, technique or helicopter type and is intended to show a generic example. An approach profile and a back-up procedure for departure profile are depicted. Specific manufacturers' operations in performance class 1 may be represented differently in the specific helicopter flight manual (HMF). CAD 6, Part 3, Attachment A provides back-up procedures that may be useful for operations in performance class 1.

Note 2. — The approach/landing profile may not be the reverse of the take-off profile.

Note 3. — Additional obstacle assessment might be required in the area that a back-up procedure is intended. Helicopter performance and the HFM limitations will determine the extent of the assessment required.

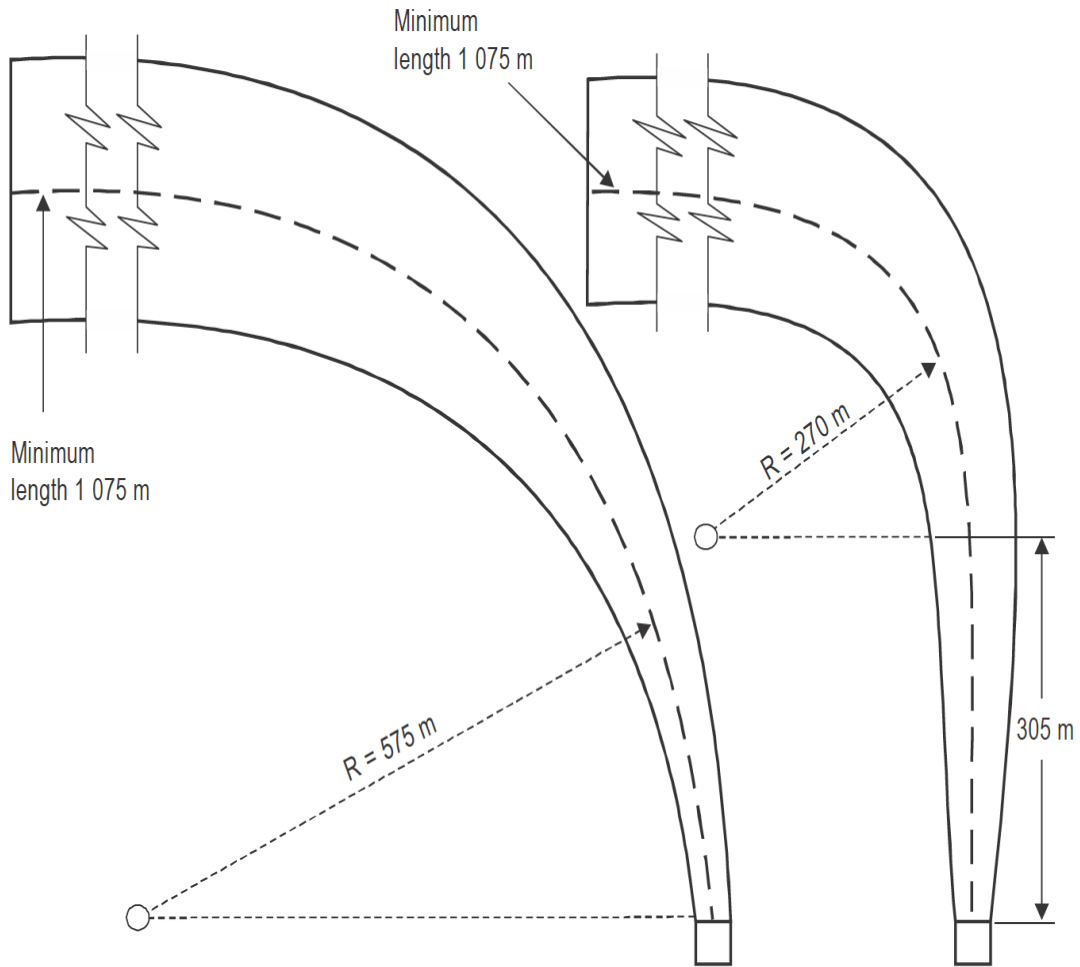

Note 1.— Any combination of curve and straight portion may be established using the following formula:
 $S+R \geq 575$ m and $R \geq 270$ m where $S = 305$ m, where S is the length of the straight portion
and R is the radius of turn. Note any combination ≥ 575 m will work.

Note 2.— The minimum length of the centre line of the curve and straight portion is 1 075 m but may be
longer depending upon the slope used. See Table 4-1 for longer lengths.

Note 3.— Helicopter take-off performance is reduced in a curve and as such a straight portion along the
take-off climb surface prior to the start of the curve should be considered to allow for acceleration.

Figure 4-5. Curved approach and take-off climb surface for all FATOs

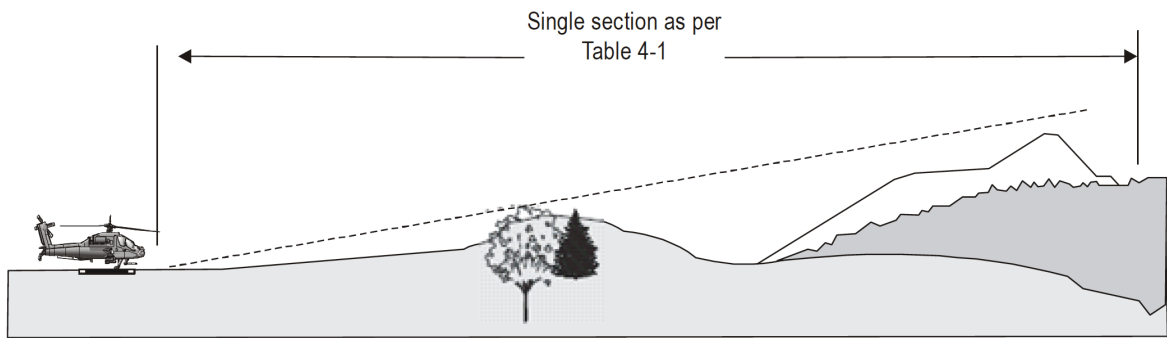

a) Approach and take-off climb surfaces - "A" slope profile - 4.5% design

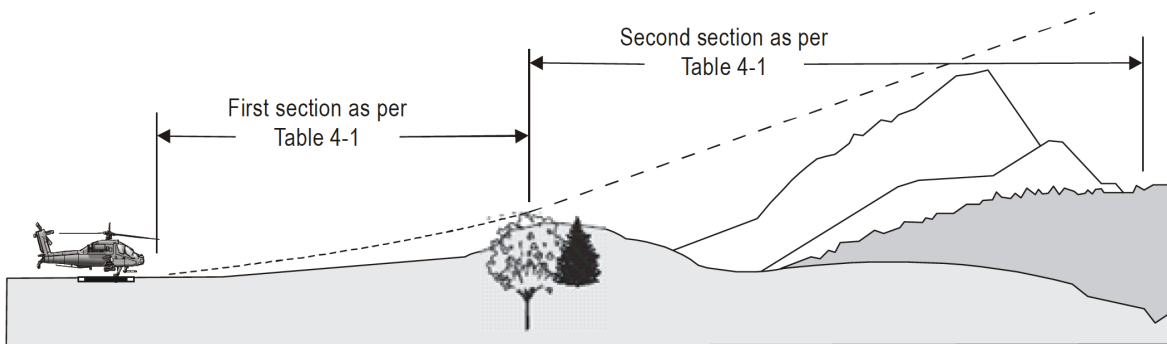

b) Approach and take-off climb surfaces - "B" slope profile - 8% and 16% design

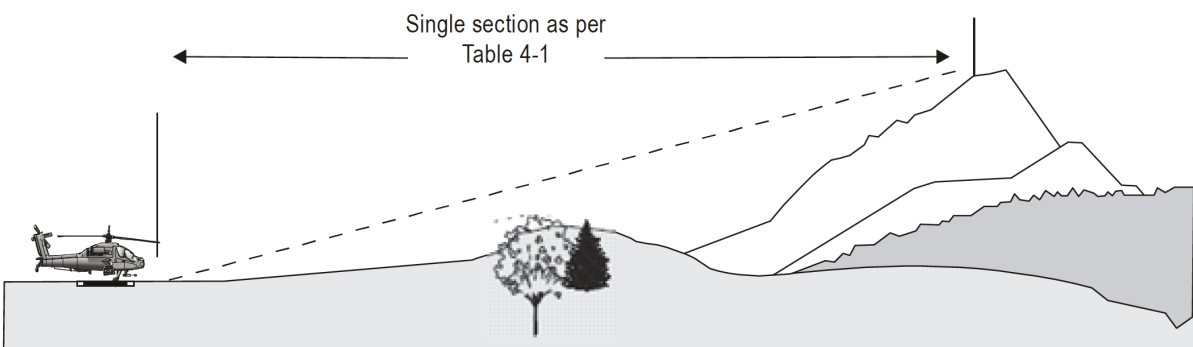

c) Approach and take-off climb surfaces - "C" slope profile - 12.5% design

Figure 4-6. Approach and take-off climb surfaces with different slope design categories

Elevated heliports

- 4.2.9 The obstacle limitation surfaces for elevated heliports shall conform to the requirements for surface-level heliports specified in 4.2.1 to 4.2.6.
- 4.2.10 An elevated heliport shall have at least one approach and take-off climb surface. An aeronautical study shall be undertaken when only a single approach and take-off climb surface is provided considering as a minimum, the following factors:
- the area/terrain over which the flight is being conducted;
 - the obstacle environment surrounding the heliport and the availability of at least one protected side slope;
 - the performance and operating limitations of helicopters intending to use the heliport; and
 - the local meteorological conditions including the prevailing winds.

Note. — See the ICAO Heliport Manual (Doc 9261) for guidance.

- 4.2.11 *RESERVED*

Helidecks

- 4.2.12 A helideck shall have an obstacle-free sector.
- Note.* — A helideck may have a LOS (~~see 4.2.25~~). (see 4.1.26)
- 4.2.13 There shall be no fixed obstacles within the obstacle-free sector above the obstacle-free surface.
- 4.2.14 In the immediate vicinity of the helideck, obstacle protection for helicopters shall be provided below the helideck level. This protection shall extend over an arc of at least 180 degrees with the origin at the centre of the FATO, with a descending gradient having a ratio of one unit horizontally to five units vertically from the edges of the FATO within the 180-degree sector. This descending gradient may be reduced to a ratio of one unit horizontally to three units vertically within the 180-degree sector for multi-engine helicopters operated in performance class 1 or 2. (See Figure 4-7.)

Note. — Where there is a requirement to position, at sea surface level, one or more offshore support vessel(s) (e.g. a Standby Vessel) essential to the operation of a fixed or floating offshore facility, but located within the proximity of the fixed or floating offshore facility, any offshore support vessel(s) would need to be positioned so as not to compromise the safety of helicopter operations during take-off departure and/or approach to landing.

- 4.2.15 For a TLOF of 1 D and larger, within the 150-degree limited obstacle surface/sector out to a distance of 0.12 D measured from the point of origin of the LOS, objects shall not exceed a height of 25 cm above the TLOF. Beyond that arc, out to an overall distance of a further 0.21 D measured from the end of the first

sector, the limited obstacle surface rises at a rate of one unit vertically for each two units horizontally originating at a height 0.05 D above the level of the TLOF. (See Figure 4-8.)

Note. — Where the area enclosed by the TLOF perimeter marking is a shape other than circular, the extent of the LOS segments are represented as lines parallel to the perimeter of the TLOF rather than arcs. Figure 4-8 has been constructed on the assumption that an octagonal helideck arrangement is provided. Further guidance for square (quadrilateral) and circular FATO and TLOF arrangements is given in the Heliport Manual (Doc 9261).

- 4.2.16 For a TLOF less than 1 D within the 150-degree limited obstacle surface/sector out to a distance of 0.62 D and commencing from a distance 0.5 D, both measured from the centre of the TLOF, objects shall not exceed a height of 5 cm above the TLOF. Beyond that arc, out to an overall distance of 0.83 D from the centre of the TLOF, the limited obstacle surface rises at a rate of one unit vertically for each two units horizontally originating at a height 0.05 D above the level of the TLOF. (See Figure 4-9.)

Note. — Where the area enclosed by the TLOF perimeter marking is a shape other than circular, the extent of the LOS segments are represented as lines parallel to the perimeter of the TLOF rather than arcs. Figure 4-9 has been constructed on the assumption that an octagonal helideck arrangement is provided. Further guidance for square (quadrilateral) and circular FATO and TLOF arrangements is given in the Heliport Manual (Doc 9261).

Shipboard heliports

- 4.2.17 The specifications in 4.2.20 and 4.2.22 shall be applicable for shipboard heliports completed on or after 1 January 2012.

Purpose-built heliports located forward or aft

- 4.2.18 When helicopter operating areas are provided in the bow or stern of a ship, they shall apply the obstacle criteria for helidecks.

Amidships location — Purpose-built and non-purpose-built

- 4.2.19 Forward and aft of a TLOF of 1 D and larger shall be two symmetrically located sectors, each covering an arc of 150 degrees, with their apexes on the periphery of the TLOF. Within the area enclosed by these two sectors, there shall be no objects rising above the level of the TLOF, except those aids essential for the safe operation of a helicopter and then only up to a maximum height of 25 cm.

- 4.2.20 Objects whose function requires them to be located within the TLOF (such as lighting or nets) shall not exceed a height of 2.5 cm. Such objects shall only be present if they do not represent a hazard to helicopters.

Note. — Examples of potential hazards include nets or raised fittings on the deck that might induce dynamic rollover for helicopters equipped with skids.

- 4.2.21 To provide further protection from obstacles fore and aft of the TLOF, rising surfaces with gradients of one unit vertically to five units horizontally shall extend from the entire length of the edges of the two 150-degree sectors. These surfaces shall extend for a horizontal distance equal to at least 1 D of the largest helicopter the TLOF is intended to serve and shall not be penetrated by any obstacle. (See Figure 4-10.)

Non-purpose-built heliports — Ship's side location

- 4.2.22 No objects shall be located within the TLOF except those aids essential for the safe operation of a helicopter (such as nets or lighting) and then only up to a maximum height of 2.5 cm. Such objects shall only be present if they do not represent a hazard to helicopters.
- 4.2.23 From the fore and aft mid-points of the D circle in two segments outside the circle, limited obstacle areas shall extend to the ship's rail to a fore and aft distance of 1.5 times the fore-to-aft-dimension of the TLOF, located symmetrically about the athwartships bisector of the D circle. Within these areas there shall be no objects rising above a maximum height of 25 cm above the level of the TLOF. (See Figure 4-11.) Such objects shall only be present if they do not represent a hazard to helicopters. (See 4.2.40)
- 4.2.24 A LOS horizontal surface shall be provided, at least 0.25 D beyond the diameter of the D circle, which shall surround the inboard sides of the TLOF to the fore and aft mid-points of the D circle. The LOS shall continue to the ship's rail to a fore and aft distance of 2.0 times the fore-to-aft dimension of the TLOF, located symmetrically about the athwartships bisector of the D circle. Within this sector there shall be no objects rising above a maximum height of 25 cm above the level of the TLOF.

Note. — Any objects located within the areas described in 4.2.23 and 4.2.24 that exceed the height of the TLOF are notified to the helicopter operator using a ship's helicopter landing area plan. For notification purposes, it may be necessary to consider immovable objects beyond the limit of the surface prescribed in 4.2.24, particularly if objects are significantly higher than 25 cm and in close proximity to the boundary of the LOS. See the Heliport Manual (Doc 9261) for guidance.

Winching areas

- 4.2.25 An area designated for winching on-board ships shall be comprised of a circular clear zone of diameter 5 m and, extending from the perimeter of the clear zone, a concentric manoeuvring zone of diameter 2 D. (See Figure 4-12.)
- 4.2.26 The manoeuvring zone shall be comprised of two areas:



- a) a) the inner manoeuvring zone extending from the perimeter of the clear zone and of a circle of diameter not less than 1.5 D; and
- b) b) the outer manoeuvring zone extending from the perimeter of the inner manoeuvring zone and of a circle of diameter not less than 2 D.S

4.2.27 Within the clear zone of a designated winching area, no objects shall be located above the level of its surface.

4.2.28 Objects located within the inner manoeuvring zone of a designated winching area shall not exceed a height of 3 m.

4.2.29 Objects located within the outer manoeuvring zone of a designated winching area shall not exceed a height of 6 m.

Note. — See the Heliport Manual (Doc 9261) for guidance

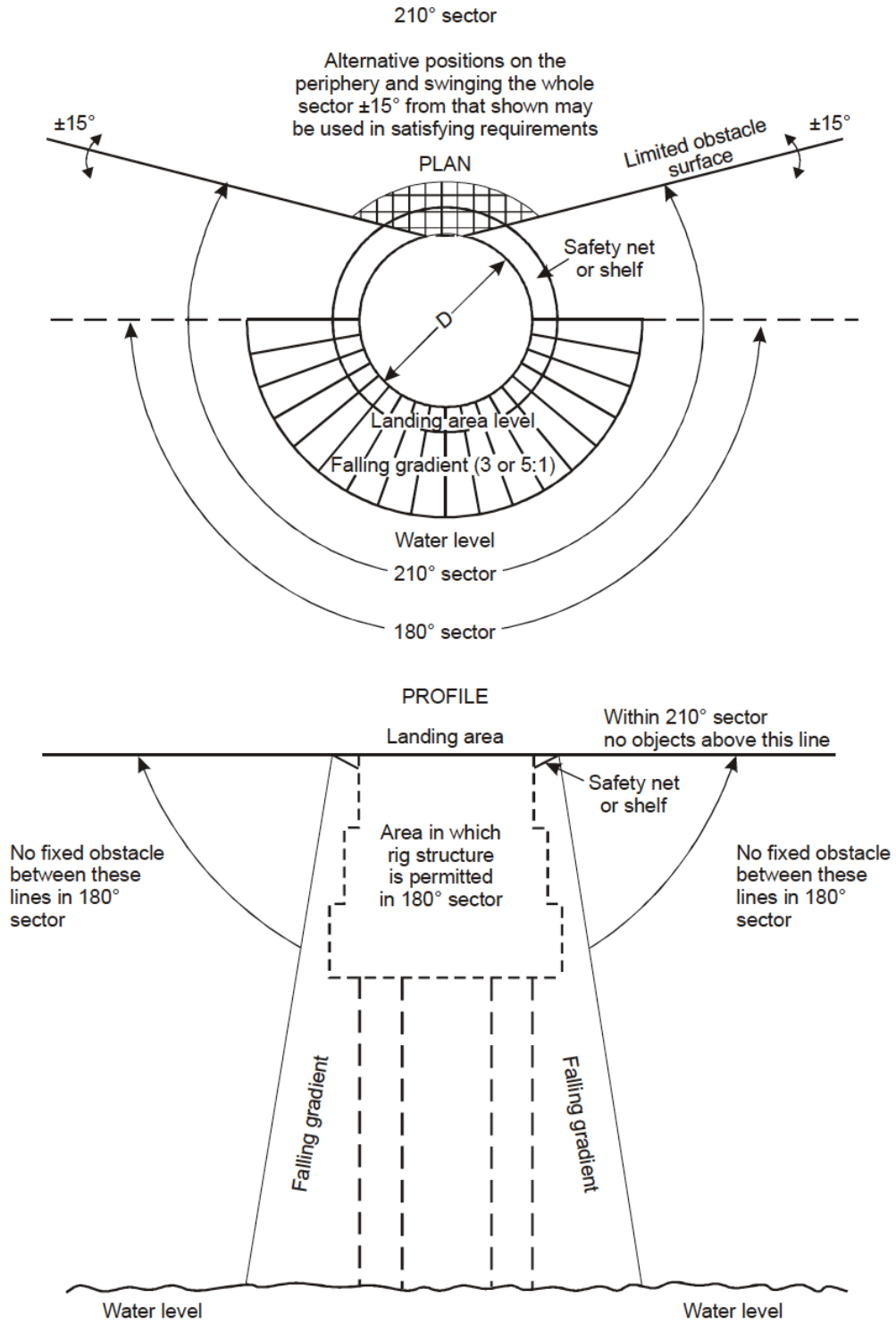

Figure 4-7. Helideck obstacle-free sector

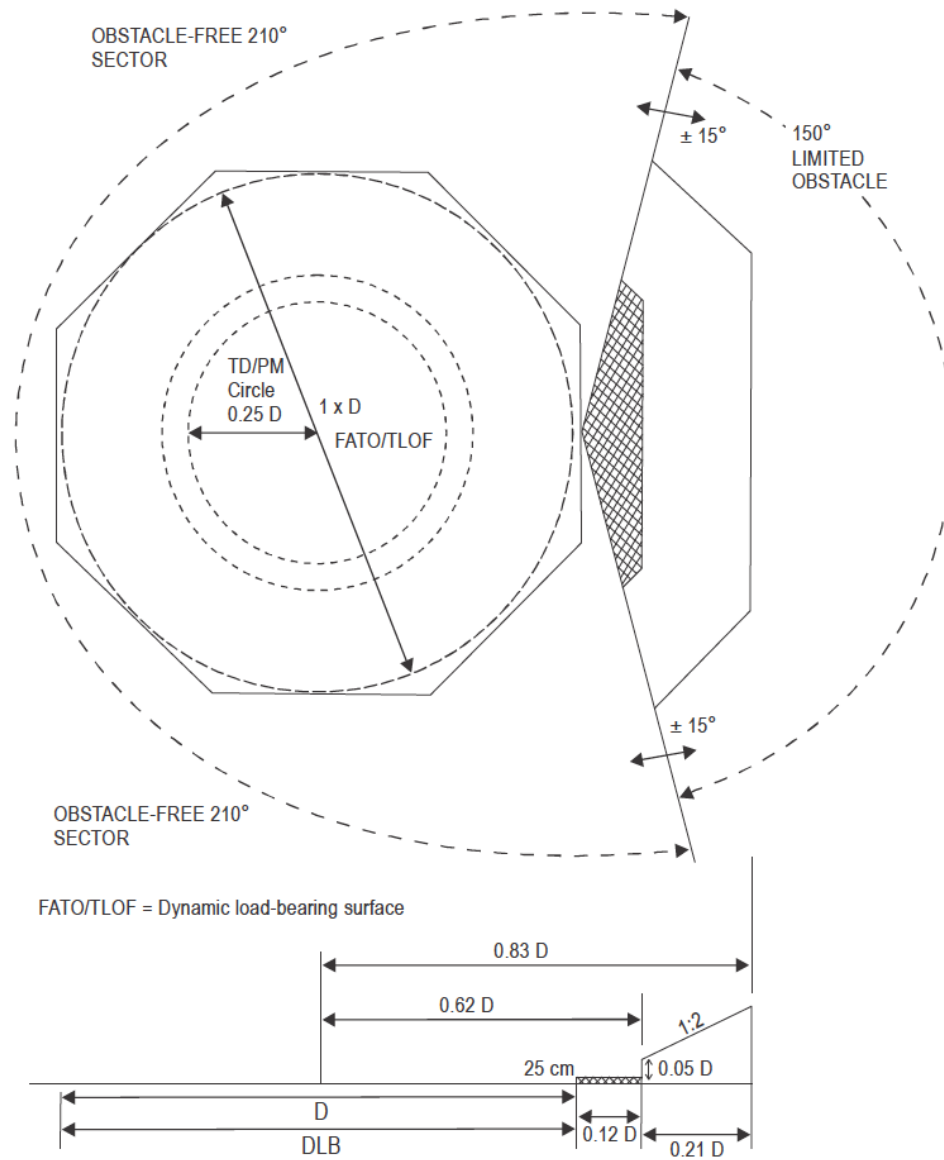
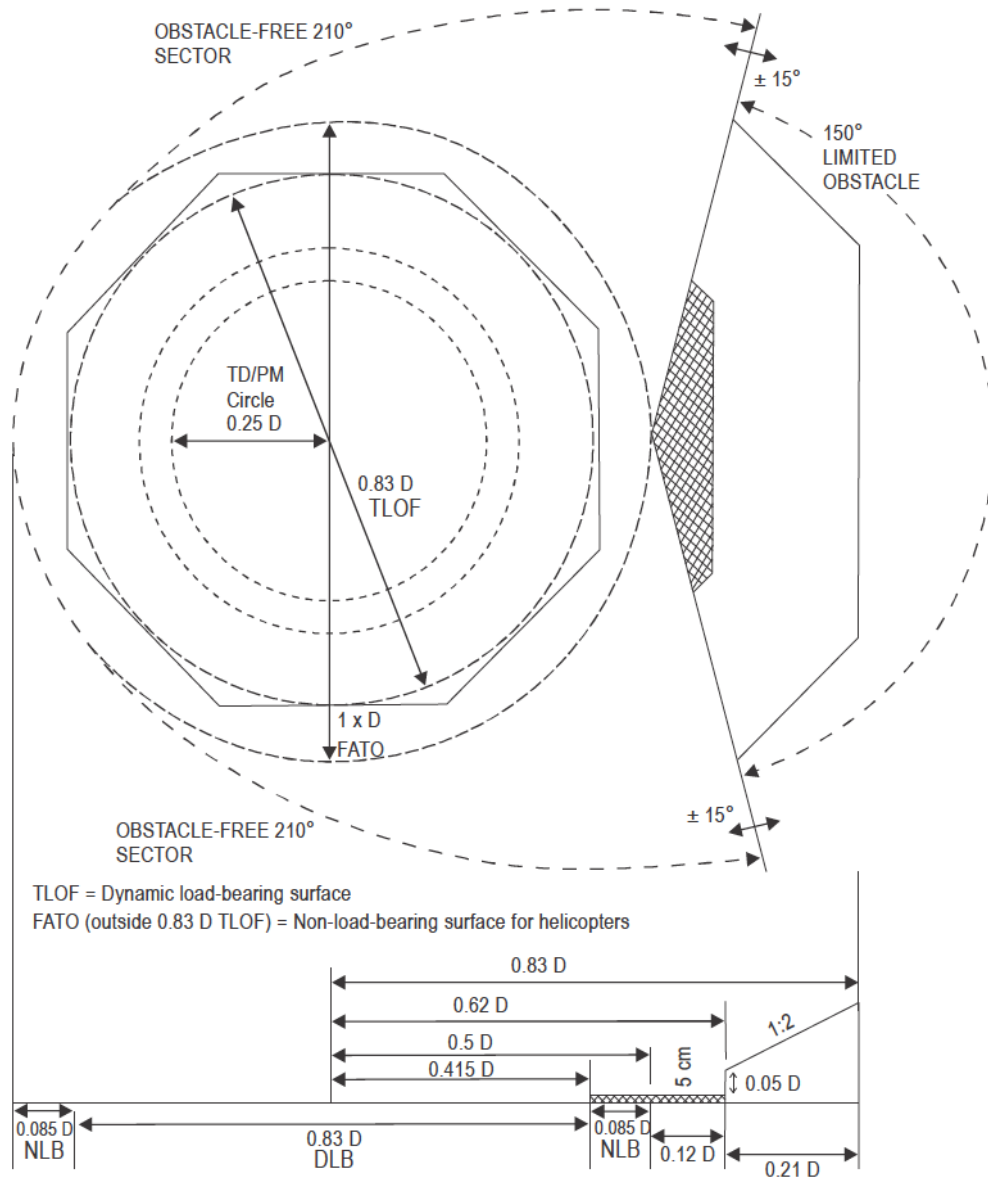
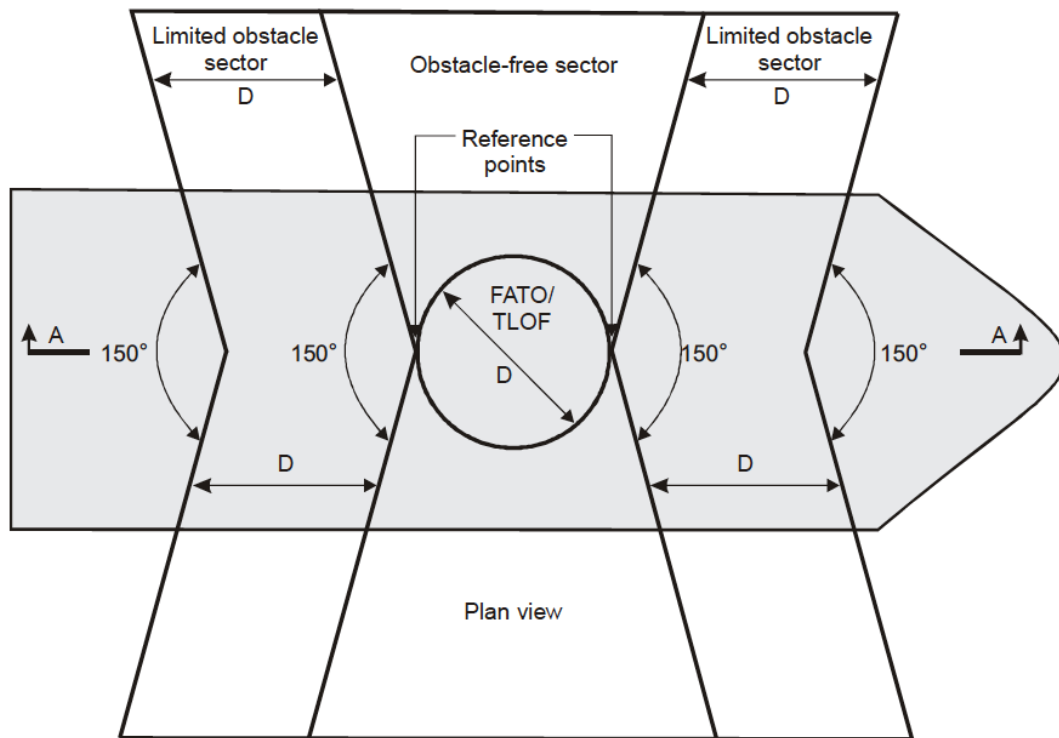

Figure 4-8. Helideck obstacle limitation sectors and surfaces for a FATO and coincidental TLOF of 1 D and larger



Note.— Shaded area indicating height of 5 cm not to scale.

Figure 4-9. Helideck obstacle limitation sectors and surfaces for a TLOF of 0.83 D and larger



D = Helicopter largest overall dimension

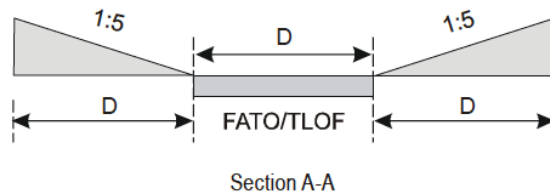

Figure 4-10. Amidship's location — shipboard heliport obstacle limitation surfaces

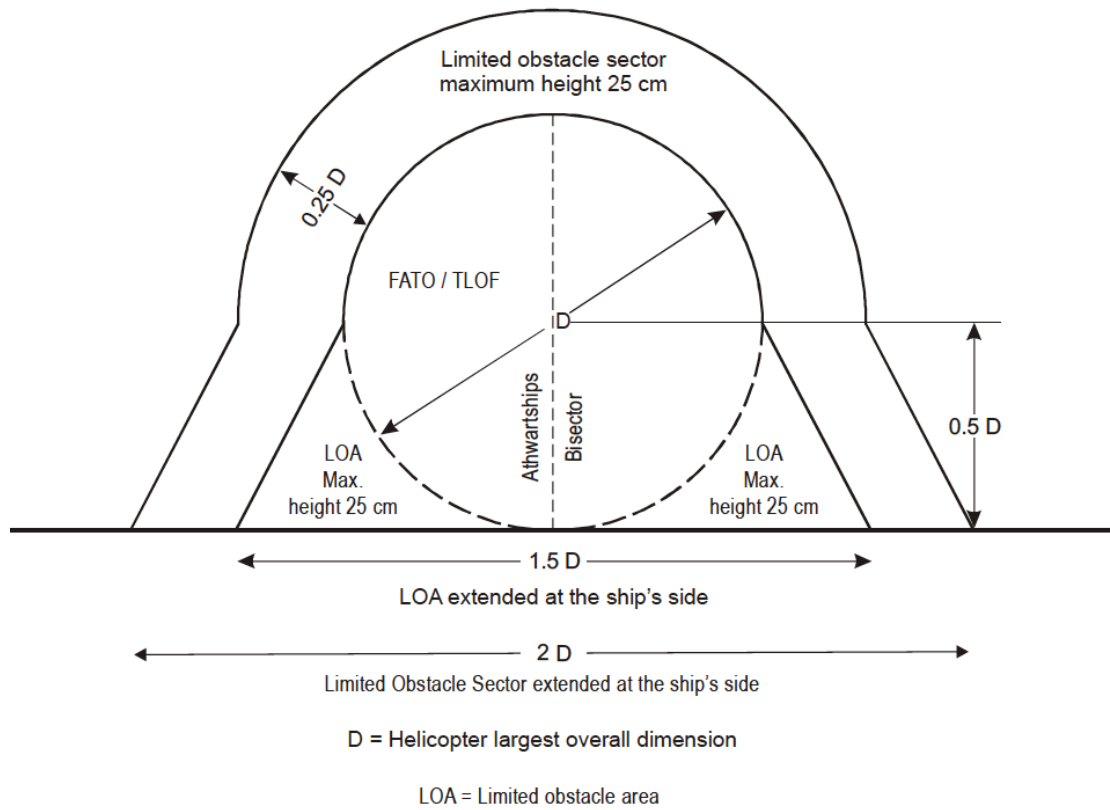

Figure 4-11. Ships-side non-purpose-built heliport obstacle limitation sectors and surfaces

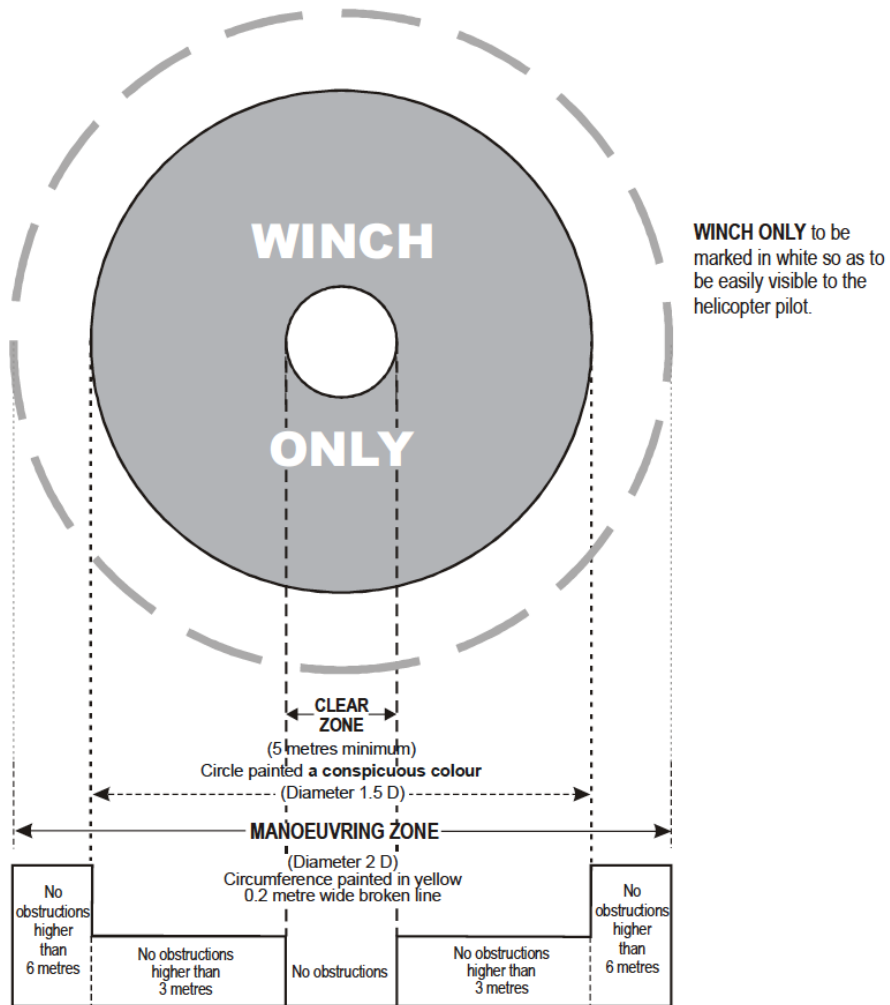

Figure 4-12. Winching area of a ship



INTENTIONALLY LEFT BLANK

5 Visual Aids

Note 1. — The procedures used by some helicopters require that they utilise a FATO having characteristics similar in shape to a runway for fixed wing aircraft. For the purpose of this chapter, a FATO having characteristics similar in shape to a runway is considered as satisfying the concept for a “runway-type FATO”. For such arrangements it is sometimes necessary to provide specific markings to enable a pilot to distinguish a runway-type FATO during an approach. Appropriate markings are contained within sub-sections entitled “Runway-type FATOs”. The requirements applicable to all other types of FATOs are given within sub-sections entitled “All FATOs except runway-type FATOs”.

Note 2. — It has been found that, on surfaces of light colour, the conspicuity of white and yellow markings can be improved by outlining them in black.

Note 3. — Guidance is given in the ICAO Heliport Manual (Doc 9261) on marking the maximum allowable mass (5.2.3) and the D-value (5.2.4) on the heliport surface to avoid confusion between markings where metric units are used and markings where imperial units are used.

Note 4. — For a non-purpose-built heliport located on a ship’s side the surface colour of the main deck can vary from ship to ship and therefore some discretion may need to be exercised in the colour selection of heliport paint schemes, the objective being to ensure that the markings are conspicuous against the surface of the ship and the operating background.

5.1 Indicators

5.1.1 Wind direction indicators

Application

5.1.1.1 A heliport shall be equipped with at least one wind direction indicator.

Location

5.1.1.2 A wind direction indicator shall be located so as to indicate the wind conditions over the FATO and TLOF and in such a way as to be free from the effects of airflow disturbances caused by nearby objects or rotor downwash. It shall be visible from a helicopter in flight, in a hover or on the movement area.

5.1.1.3 Where a TLOF and/or FATO may be subject to a disturbed airflow, additional wind direction indicators located close to the area shall be provided to indicate the surface wind on the area.

Note. — Guidance on the location of wind direction indicators is given in the ICAO Heliport Manual (Doc 9261).

Characteristics

5.1.1.4 A wind direction indicator shall be constructed so that it gives a clear indication of the direction of the wind and a general indication of the wind speed.

5.1.1.5 A wind direction indicator shall be a truncated cone made of lightweight fabric and shall have the following minimum dimensions:

	Surface-level heliports	Elevated heliports and helideck
<i>Length</i>	2.4 m	1.2 m
<i>Diameter (larger end)</i>	0.6 m	0.3 m
<i>Diameter (smaller end)</i>	0.3 m	0.15 m

5.1.1.6 The colour of the wind direction indicator shall be so selected as to make it clearly visible and understandable from a height of at least 200 m above the heliport, having regard to background. Where practicable, a single colour, preferably white or orange, shall be used. Where a combination of two colours is required to give adequate conspicuity against changing backgrounds, they shall preferably be orange and white, red and white, or black and white, and shall be arranged in five alternate bands the first and last band being the darker colour.

5.1.1.7 A wind direction indicator at a heliport intended for use at night shall be illuminated.

5.2 Markings and markers

Note. — See CAD 14, Vol. I, 5.2.1.4, Note 1, concerning improving conspicuity of markings.

5.2.1 Winching area marking

Note. — The objective of winching area markings is to provide to the pilot visual cues to assist a helicopter to be positioned over, and retained within, an area from which a passenger or equipment can be lowered or raised.

Application

5.2.1.1 Winching area markings shall be provided at a designated winching area. (See Figure 4-12.)

Location

5.2.1.2 Winching area markings shall be located so that their centre(s) coincides with the centre of the clear zone of the winching area. (See Figure 4-12.)

Characteristics

5.2.1.3 Winching area markings shall comprise a winching area clear zone marking and a winching area manoeuvring zone marking.

5.2.1.4 A winching area clear zone marking shall consist of a solid circle of diameter not less than 5 m and of a conspicuous colour.

5.2.1.5 A winching area manoeuvring zone marking shall consist of a broken circle line of 30 cm in width and of a diameter not less than 2D and be marked in a conspicuous colour. Within it “WINCH ONLY” shall be marked to be easily visible to the pilot.

5.2.2 Heliport identification marking

Application

5.2.2.1 A heliport identification marking shall be provided at a heliport.

Location — All FATOs except runway-type FATOs

5.2.2.2 A heliport identification marking shall be located at or near the centre of the FATO.

Note 1. — The objective of heliport identification marking is to provide to the pilot an indication of the presence of a heliport and, by its form, the likely usage; the preferred direction(s) of approach; or the FATO orientation within the helideck obstacle environment.

Note 2. — For other than helidecks, the preferred direction(s) of approach corresponds to the median of the departure/arrival surface(s).

Note 3. — For helidecks, the bar of the “H” points to the centre of the limited obstacle sector (LOS).

Note 4. — If the touchdown/positioning marking (TDPM) is offset, the heliport identification marking is established in the centre of the TDPM.

Note 5. — On a FATO which does not contain a TLOF and which is marked with an aiming point marking (see 5.2.7), the heliport identification marking is established in the centre of the aiming point marking as shown in Figures 5-1 and 5-2.

5.2.2.3 On a FATO which contains a TLOF, a heliport identification marking shall be located in the FATO so the position of it coincides with the centre of the TLOF.

Location — Runway-type FATOs

5.2.2.4 A heliport identification marking shall be located in the FATO and when used in conjunction with FATO designation markings, shall be displayed at each end of the FATO as shown in Figure 5-3.

Characteristics

5.2.2.5 A heliport identification marking, except for a heliport at a hospital, shall consist of a letter H, in white. The dimensions of the H marking shall be no less than those shown in Figure 5-4 and where the marking is used for a runway type FATO, its dimensions shall be increased by a factor of 3 as shown in Figure 5-3.

- 5.2.2.6 A heliport identification marking for a heliport at a hospital shall consist of a letter H, red in colour, on a white cross made of squares adjacent to each of the sides of a square containing the H as shown in Figures 5-2 and 5-4.
- 5.2.2.7 A heliport identification marking shall be oriented with the cross arm of the H at right angles to the preferred final approach direction. For a helideck, the cross arm shall be on or parallel to the bisector of the obstacle-free sector. For a non-purpose-built shipboard heliport located on a ship's side, the cross arm shall be parallel with the side of the ship.
- 5.2.2.8 On a helideck or a shipboard heliport where the D-value is 16.0 m or larger, the size of the heliport identification H marking shall have a height of 4 m with an overall width not exceeding 3 m and a stroke width not exceeding 0.75 m. Where the D-value is less than 16.0 m, the size of the heliport identification H marking shall have a height of 3 m with an overall width not exceeding 2.25 m and a stroke width not exceeding 0.5 m.

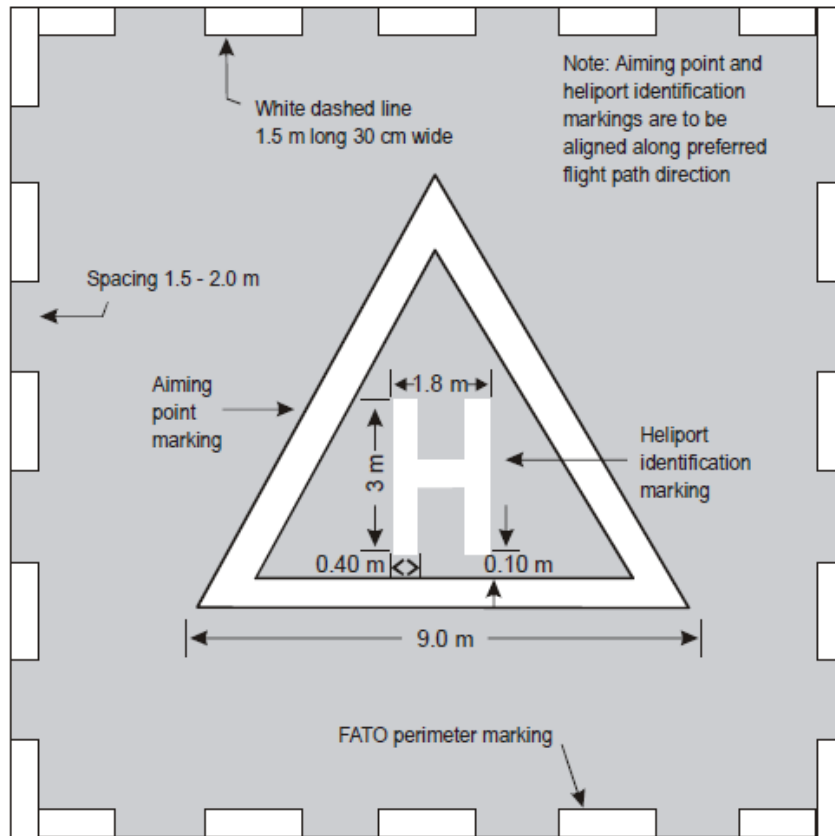

Note: The aiming point, heliport identification and FATO perimeter markings are white and may be edged with a 10 cm black border to improve contrast

Figure 5-1. Combined heliport identification, aiming point and FATO perimeter marking

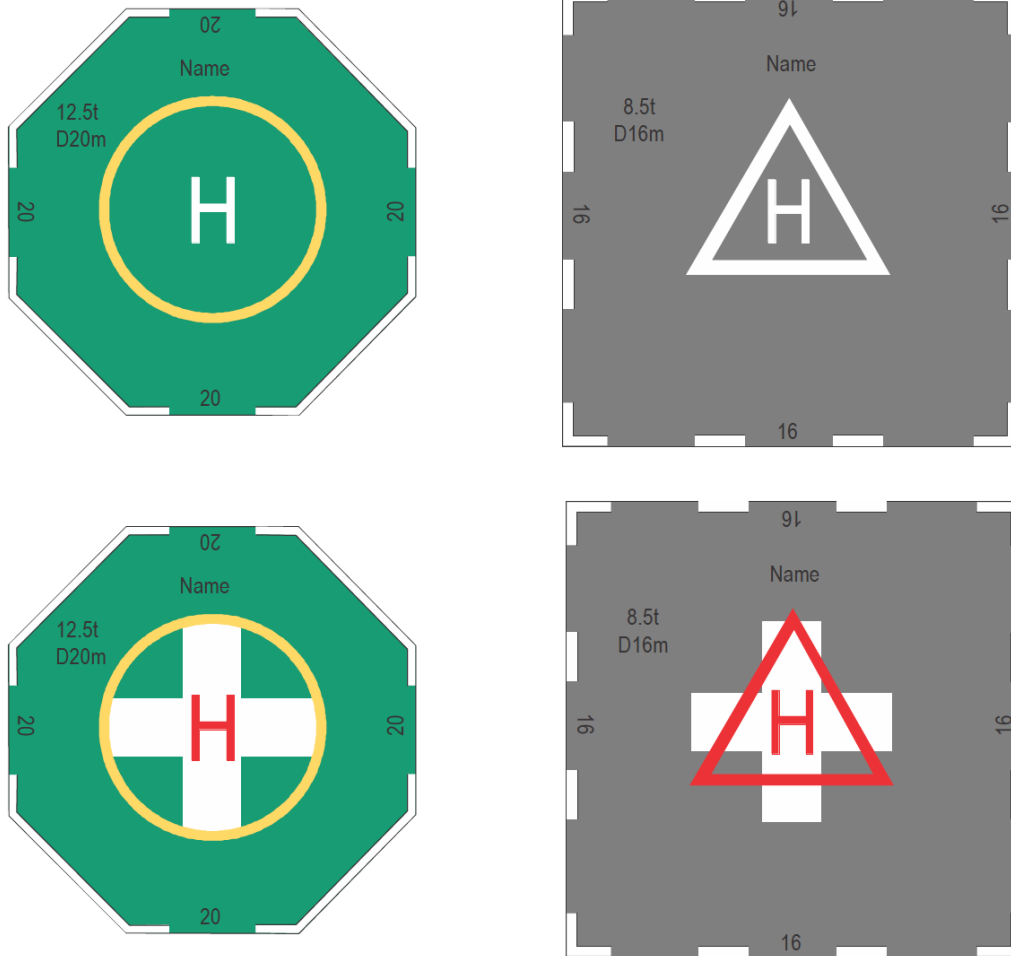

Figure 5-2. Heliport identification markings with TLOF and aiming markings for heliport and hospital heliport



Figure 5-3. FATO designation marking and heliport identification marking for a runway-type FATO

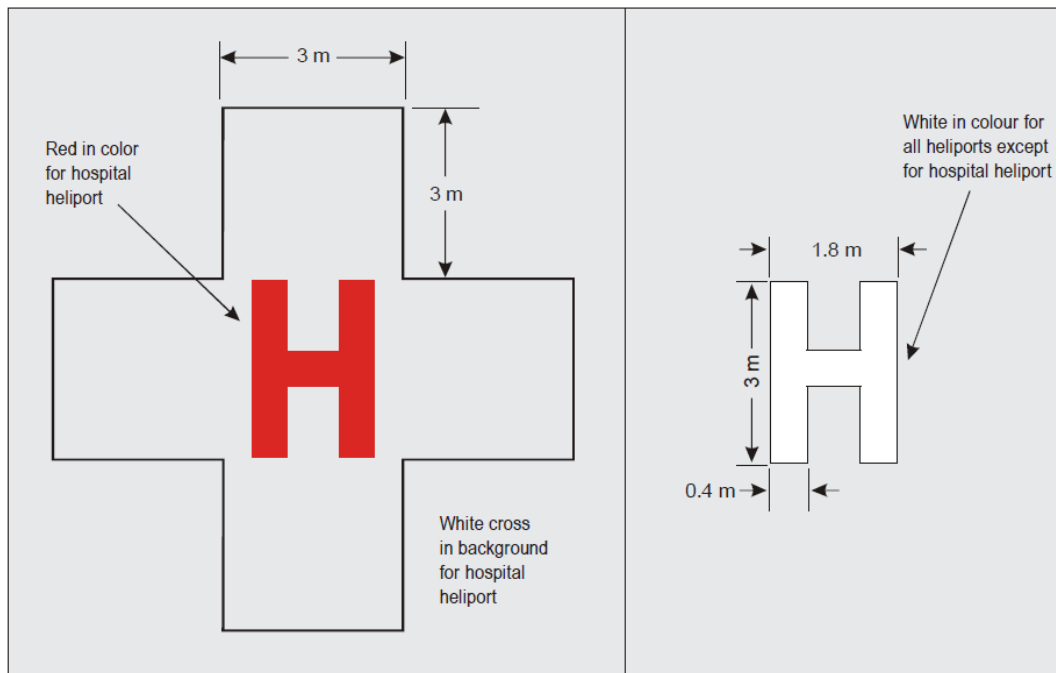

Figure 5-4. Hospital heliport identification and heliport identification marking

5.2.3 Maximum allowable mass marking

Note 1. — The objective of the maximum allowable mass marking is to provide the mass limitation of the heliport such that it is visible to the pilot from the preferred final approach direction.

Note 2. — RESERVED

Application

5.2.3.1 A maximum allowable mass marking shall be displayed at an elevated heliport, a helideck and a shipboard heliport.

5.2.3.2 *RESERVED*

Location

- 5.2.3.3 A maximum allowable mass marking shall be located within the TLOF or FATO and so arranged as to be readable from the preferred final approach direction.

Characteristics

- 5.2.3.4 A maximum allowable mass marking shall consist of a one-, two- or three-digit number.
- 5.2.3.5 The maximum allowable mass shall be expressed in tonnes (1 000 kg) rounded down to the nearest 1 000 kg followed by the letter “t”.
- 5.2.3.6 The maximum allowable mass shall be expressed to the nearest 100 kg. The marking shall be presented to one decimal place and rounded to the nearest 100 kg followed by the letter “t”.
- 5.2.3.7 When the maximum allowable mass is expressed to 100 kg, the decimal place shall be preceded with a decimal point marked with a 30 cm square.

All FATOs except runway-type FATOs

- 5.2.3.8 The numbers and the letter of the marking shall have a colour contrasting with the background and shall be in the form and proportion shown in Figure 5-5 for a D-value of more than 30 m. For a D-value between 15 m and 30 m, the height of the numbers and the letter of the marking shall be a minimum of 90 cm, and for a D-value of less than 15 m, the height of the numbers and the letter of the marking shall be a minimum of 60 cm, each with a proportional reduction in width and thickness.

Runway-type FATOs

- 5.2.3.9 The numbers and the letter of the marking shall have a colour contrasting with the background and shall be in the form and proportion shown in Figure 5-5.

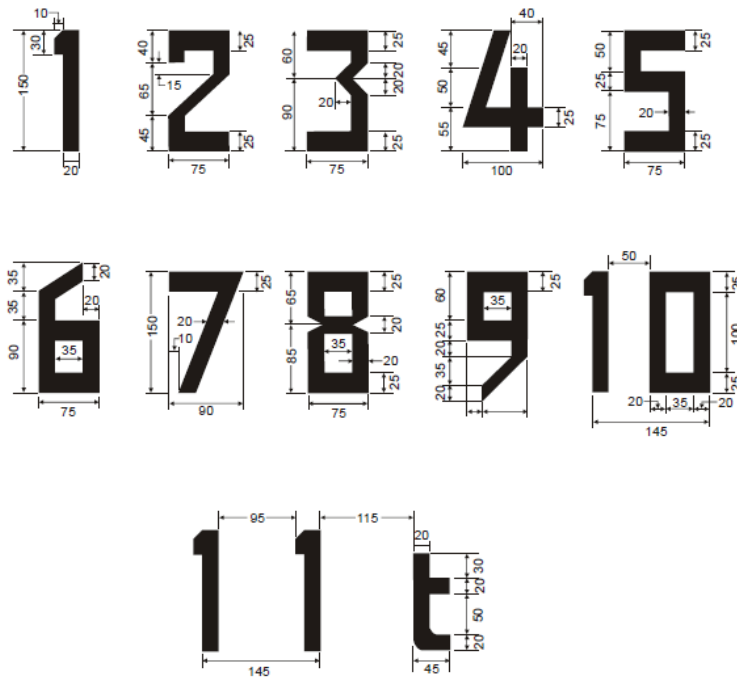

Note.— All units are expressed in centimetres.

Figure 5-5. Form and proportions of numbers and letters

5.2.4 D-value marking

Note. — The objective of D-value marking is to provide to the pilot the “D” of the largest helicopter that can be accommodated on the heliport. This value may differ in size from the FATO and the TLOF provided in compliance with Chapter 3.

Application — All FATOs except runway-type FATOs

5.2.4.1 A D-value marking shall be displayed at a helideck and at a shipboard heliport.

Application — Runway-type FATOs

Note. — The D-value is not required to be marked on a heliport with a runway-type FATO.

5.2.4.2 A D-value marking shall be displayed at surface-level and elevated heliports.

Location

5.2.4.3 A D-value marking shall be located within the TLOF or FATO and so arranged as to be readable from the preferred final approach direction.

5.2.4.4 Where there is more than one approach direction, additional D-value markings shall be provided such that at least one D-value marking is readable from the final approach direction. For a non-purpose-built heliport located on a ship’s side, D-value markings shall be provided on the perimeter of the D circle at the 2 o’clock, 10 o’clock and 12 o’clock positions when viewed from the side of the ship facing towards the centre line.

Characteristics

- 5.2.4.5 The D-value marking shall be white or black. The D-value marking shall be rounded to the nearest whole metre with 0.5 rounded down.
- 5.2.4.6 The numbers of the marking shall have a colour contrasting with the background and shall be in the form and proportion shown in Figure 5-5 for a D-value of more than 30 m. For a D-value between 15 m and 30 m, the height of the numbers of the marking shall be a minimum of 90 cm, and for a D-value of less than 15 m, the height of the numbers of the marking shall be a minimum of 60 cm, each with a proportional reduction in width and thickness.
- 5.2.5 FATO perimeter marking or markers for surface-level heliports

Note. — The objective of FATO perimeter marking or markers is to provide to the pilot, where the perimeter of the FATO is not self-evident, an indication of the area that is free of obstacles and in which intended procedures or permitted manoeuvring may take place.

Application

- 5.2.5.1 FATO perimeter marking or markers shall be provided at a surface-level heliport where the extent of a FATO with a solid surface is not self-evident.

Location

- 5.2.5.2 The FATO perimeter marking or markers shall be located on the edge of the FATO.

Characteristics — Runway-type FATOs

- 5.2.5.3 The perimeter of the FATO shall be defined with markings or markers spaced at equal intervals of not more than 50 m with at least three markings or markers on each side including a marking or marker at each corner.
- 5.2.5.4 A FATO perimeter marking shall be a rectangular stripe with a length of 9 m or one-fifth of the side of the FATO which it defines and a width of 1 m.
- 5.2.5.5 FATO perimeter markings shall be white.
- 5.2.5.6 A FATO perimeter marker shall have dimensional characteristics as shown in Figure 5-6.
- 5.2.5.7 FATO perimeter markers shall be of colour(s) that contrast effectively against the operating background.
- 5.2.5.8 FATO perimeter markers shall be a single colour, orange or red, or two contrasting colours, orange and white or, alternatively, red and white shall be used except where such colours would merge with the background.

Characteristics — All FATOs except runway-type FATOs

- 5.2.5.9 For an unpaved FATO the perimeter shall be defined with flush in-ground markers. The FATO perimeter markers shall be 30 cm in width, 1.5 m in length, and with end-to-end spacing of not less than 1.5 m and not more than 2 m. The corners of a square or rectangular FATO shall be defined.
- 5.2.5.10 For a paved FATO the perimeter shall be defined with a dashed line. The FATO perimeter marking segments shall be 30 cm in width, 1.5 m in length, and with end-to-end spacing of not less than 1.5 m and not more than 2 m. The corners of the square or rectangular FATO shall be defined.
- 5.2.5.11 FATO perimeter markings and flush in-ground markers shall be white.

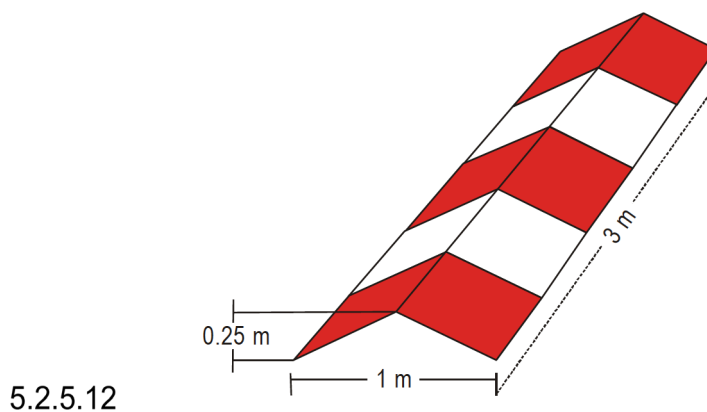

5.2.5.12

Figure 5-6. Runway-type FATO edge marker

- 5.2.6 FATO designation markings for runway-type FATOs

Note. — The objective of FATO designation markings for runway-type FATOs is to provide to the pilot an indication of the magnetic heading of the runway.

Application

- 5.2.6.1 A FATO designation marking shall be provided at a heliport where it is necessary to designate the FATO to the pilot.

Location

- 5.2.6.2 A FATO designation marking shall be located at the beginning of the FATO as shown in Figure 5-3.

Characteristics

- 5.2.6.3 A FATO designation marking shall consist of a two-digit number. The two-digit number shall be the whole number nearest to one-tenth of the magnetic North when viewed from the direction of approach. When this rule would give a single

digit number, it shall be preceded by a zero. The marking, as shown in Figure 5-3, shall be supplemented by the heliport identification marking.

5.2.7 Aiming point marking

Note. — The objective of the aiming point marking is to provide to the pilot a visual cue indicating the preferred approach/departure direction, the point to which the helicopter approaches to the hover before positioning to a stand where a touchdown can be made, and that the surface of the FATO is not intended for touchdown.

Application

5.2.7.1 An aiming point marking shall be provided at a heliport where it is necessary for a pilot to make an approach to a particular point above a FATO before proceeding to a TLOF.

Location — Runway-type FATOs

5.2.7.2 The aiming point marking shall be located within the FATO.

Location — All FATOs except runway-type FATOs

5.2.7.3 The aiming point marking shall be located at the centre of the FATO as shown in Figure 5-1.

Characteristics

5.2.7.4 The aiming point marking shall be an equilateral triangle with the bisector of one of the angles aligned with the preferred approach direction. The marking shall consist of continuous lines providing a contrast with the background colour, and the dimensions of the marking shall conform to those shown in Figure 5-7.

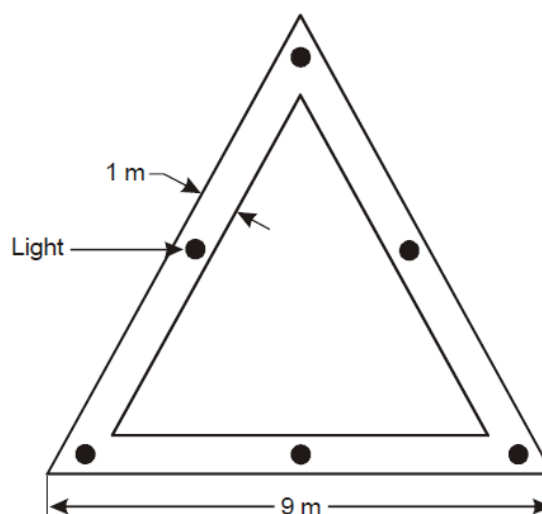

Figure 5-7. Aiming point marking

5.2.8 TLOF perimeter marking

Note. — *The objective of TLOF perimeter marking is to provide to the pilot an indication of an area that is free of obstacles; has dynamic load bearing; and in which, when positioned in accordance with the TDPM, undercarriage containment is assured.*

Application

5.2.8.1 A TLOF perimeter marking shall be displayed on a TLOF located in a FATO at a surface-level heliport if the perimeter of the TLOF is not self-evident.

5.2.8.2 A TLOF perimeter marking shall be displayed on an elevated heliport, a helideck and a shipboard heliport.

Location

5.2.8.3 A TLOF perimeter marking shall be located along the edge of the TLOF.

Characteristics

5.2.8.4 A TLOF perimeter marking shall consist of a continuous white line with a width of at least 30 cm.

5.2.9 Touchdown/positioning marking

Note. — *The objective of touchdown/positioning marking (TDPM) is to provide visual cues which permit a helicopter to be placed in a specific position such that, when the pilot's seat is above the marking, the undercarriage is within the load-bearing area and all parts of the helicopter will be clear of any obstacles by a safe margin.*

Application

5.2.9.1 A TDPM shall be provided for a helicopter to touch down or be accurately placed in a specific position.

5.2.9.2 The TDPM shall be:

- a) when there is no limitation on the direction of touchdown/positioning, a touchdown/positioning circle (TDPC) marking; and
- b) when there is a limitation on the direction of touchdown/positioning:
 - 1) for unidirectional applications, a shoulder line with an associated centre line; or
 - 2) for multidirectional applications, a TDPC marking with prohibited landing sector(s) marked.

Location

- 5.2.9.3 The inner edge/inner circumference of the TDPM shall be at a distance of 0.25D from the centre of the area in which the helicopter is to be positioned.
- 5.2.9.4 On a helideck, the centre of the TDPC marking shall be located at the centre of the TLOF except that the marking may be offset away from the origin of the obstacle-free sector by no more than 0.1D where an aeronautical study indicates such offsetting is necessary and would not impair the safety of flight operations or ground handling.
- 5.2.9.5 Prohibited landing sector markings, when provided, shall be located on the TDPM, within the relevant headings, and extend to the inner edge of the TLOF perimeter marking.

Characteristics

- 5.2.9.6 The inner diameter of the TDPC shall be 0.5D of the largest helicopter the area is intended to serve.
- 5.2.9.7 A TDPM shall be yellow and have a line width of at least 0.5 m. For a helideck and a purpose-built shipboard heliport, the line width shall be at least 1 m, except for helideck having a D-value of 16.0 m or less, the line width shall be at least 0.5 m.
- 5.2.9.8 The length of a shoulder line shall be 0.5D of the largest helicopter the area is intended to serve.
- 5.2.9.9 The prohibited landing sector marking, when provided, shall be indicated by white and red hatched markings as shown in Figure 5-8.
- 5.2.9.10 The TDPM shall take precedence when used in conjunction with other markings on the TLOF except for the prohibited landing sector marking.

Note. — The prohibited landing sector marking, when provided, is not intended to move the helicopter away from objects around the FATO, but to ensure that the tail is not placed in an orientation that might constitute a hazard. This is achieved by having the helicopter nose clear of the hatched markings during the touchdown. (See 5.2.17)

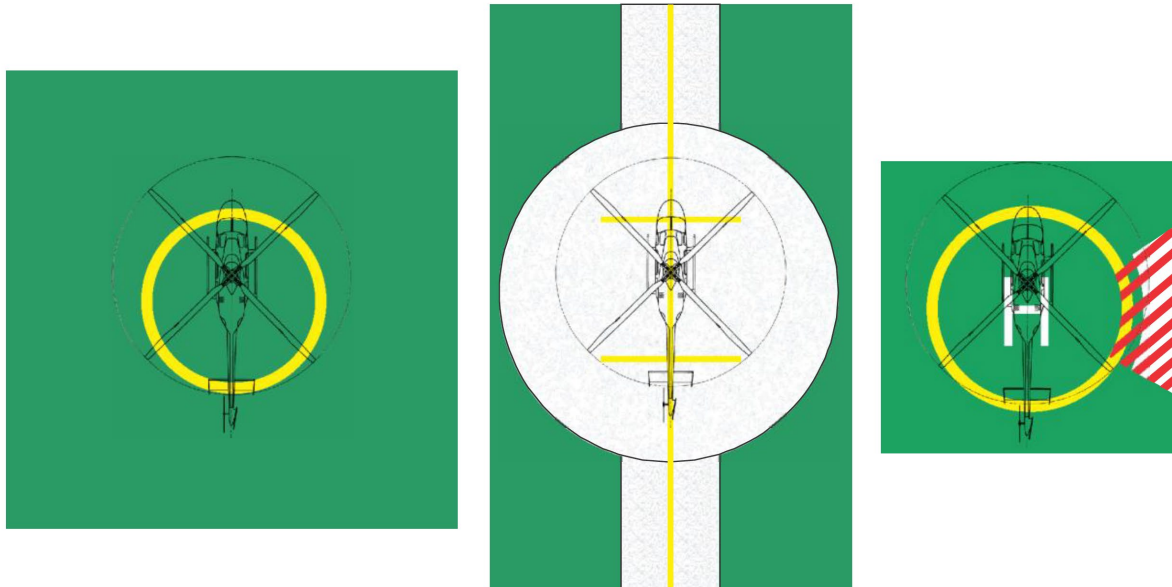

**Figure 5-8. Multidirectional TDPC with no limitations (left)
Unidirectional marking shoulder line with associated centre line (centre)
Multidirectional TDPC with prohibited landing sector marking (right)**

5.2.10 Heliport name marking

Note. — The objective of heliport name marking is to provide to the pilot a means of identifying a heliport which can be seen, and read, from all directions of approach.

Application

- 5.2.10.1 A heliport name marking shall be provided at a heliport and helideck where there is insufficient alternative means of visual identification.

Location

- 5.2.10.2 Where a limited obstacle sector (LOS) exists on a helideck, the marking shall be located on that side of the heliport identification marking. For a non-purpose-built heliport located on a ship's side, the marking shall be located on the inboard side of the heliport identification marking in the area between the TLOF perimeter marking and the boundary of the LOS.

Characteristics

- 5.2.10.3 A heliport name marking shall consist of the name or the alphanumeric designator of the heliport as used in the radio (R/T) communications.
- 5.2.10.4 A heliport name marking intended for use at night or during conditions of poor visibility shall be illuminated, either internally or externally.

Runway-type FATOs

- 5.2.10.5 The characters of the marking shall be not less than 3 m in height.

All FATOs except runway-type FATOs.

- 5.2.10.6 The characters of the marking shall be not less than 1.5 m in height at surface-level heliports and not less than 1.2 m on elevated heliports, helidecks and shipboard heliports. The colour of the marking shall contrast with the background and preferably be white.

- 5.2.11 Helideck obstacle-free sector (chevron) marking

Note 1. — The objective of helideck obstacle-free sector (chevron) marking is to indicate the direction and limits of a sector that is free of obstacles above the level of the helideck for the preferred approach and departure directions.

Application

- 5.2.11.1 A helideck with adjacent obstacles that penetrate above the level of the helideck shall have an obstacle-free sector marking.

Location

- 5.2.11.2 A helideck obstacle-free sector marking shall be located, where practicable, at a distance from the centre of the TLOF equal to the radius of the largest circle that can be drawn in the TLOF or 0.5D, whichever is greater.

Note. — Where the point of origin is outside the TLOF, and it is not practicable to physically paint the chevron, the chevron is relocated to the TLOF perimeter on the bisector of the obstacle-free sector. In this case, the distance and direction of displacement, along with the attention-getting “WARNING DISPLACED CHEVRON”, is marked in a box beneath the chevron in black characters not less than 10 cm high. (An example figure is given in the ICAO Heliport Manual (Doc 9261).

Characteristics

- 5.2.11.3 The helideck obstacle-free sector marking shall indicate the location of the obstacle-free sector and the directions of the limits of the sector.

Note. — Example figures are given in the ICAO Heliport Manual (Doc 9261).

- 5.2.11.4 The height of the chevron shall not be less than 30 cm.

- 5.2.11.5 **RESERVED**

- 5.2.11.6 The colour of the chevron shall be black.

5.2.12 Helideck and shipboard heliport surface marking

Note. — The objective of helideck and shipboard heliport surface marking is to provide to the pilot, by colour and conspicuity, the location of the TLOF on a helideck or shipboard heliport.

Application

- 5.2.12.1 A surface marking shall be provided to assist the pilot to identify the location of the helideck or shipboard heliport during an approach by day.

Location

- 5.2.12.2 A surface marking shall be applied to the dynamic load-bearing area bounded by the TLOF perimeter marking.

Characteristics

- 5.2.12.3 The helideck or shipboard heliport surface bounded by the TLOF perimeter marking shall be of dark green using a high friction coating.

Note. — Where the application of a surface coating may have a degrading effect on friction qualities, the surface might not be painted. In such cases, the best operating practice to enhance the conspicuity of markings is to outline deck markings with a contrasting colour.

5.2.13 Helicopter taxiway markings and markers

Note 1. — The objective of helicopter taxiway markings and markers is, without being a hazard to the helicopter, to provide to the pilot by day and, if necessary, by night, visual cues to guide movement along the taxiway.

Note 2. — The specifications for runway-holding position markings in CAD 14, Vol. I, 5.2.10 are equally applicable to taxiways intended for ground taxiing of helicopters.

Note 3. — Ground taxi-routes and air taxi-routes over a taxiway are not required to be marked.

Note 4. — Unless otherwise indicated, it may be assumed that a helicopter taxiway is suitable for both ground taxiing and air taxiing of helicopters.

Note 5. — Signage may be required on an aerodrome where it is necessary to indicate that a helicopter taxiway is suitable only for the use of helicopters.

Application

- 5.2.13.1 The centre line of a helicopter taxiway shall be identified with a marking.
- 5.2.13.2 The edges of a helicopter taxiway, if not self-evident, shall be identified with markers or markings.

Location

- 5.2.13.3 Helicopter taxiway markings shall be along the centre line and, if required, along the edges of a helicopter taxiway.
- 5.2.13.4 Helicopter taxiway edge markers shall be located at a distance of 1 m to 3 m beyond the edge of the helicopter taxiway.
- 5.2.13.5 Helicopter taxiway edge markers shall be spaced at intervals of not more than 15 m on each side of straight sections and 7.5 m on each side of curved sections with a minimum of four equally spaced markers per section.

Characteristics

- 5.2.13.6 On a paved taxiway, a helicopter taxiway centre line marking shall be a continuous yellow line 15 cm in width.
- 5.2.13.7 On an unpaved taxiway that will not accommodate painted markings, a helicopter taxiway centre line shall be marked with flush in-ground 15-cm-wide and approximately 1.5 m in length yellow markers, spaced at intervals of not more than 30 m on straight sections and not more than 15 m on curves, with a minimum of four equally spaced markers per section.
- 5.2.13.8 Helicopter taxiway edge markings shall be a continuous double yellow line, each 15 cm in width, and spaced 15 cm apart (nearest edge to nearest edge).
- 5.2.13.9 A helicopter taxiway edge marker shall be frangible to the wheeled undercarriage of a helicopter.
- 5.2.13.10 A helicopter taxiway edge marker shall not exceed a plane originating at a height of 25 cm above the plane of the helicopter taxiway, at a distance of 0.5 m from the edge of the helicopter taxiway and sloping upwards and outwards at a gradient of 5 per cent to a distance of 3 m beyond the edge of the helicopter taxiway.
- 5.2.13.11 A helicopter taxiway edge marker shall be blue.
- Note 1. — Guidance on suitable edge markers is given in the ICAO Heliport Manual (Doc 9261).*
- Note 2. — If blue markers are used on an aerodrome, signage may be required to indicate that the helicopter taxiway is suitable only for helicopters.*
- 5.2.13.12 If the helicopter taxiway is to be used at night, the edge markers shall be internally illuminated or retroreflective.
- 5.2.14 Helicopter air taxi-route markings and markers

Note. — The objective of helicopter air taxi-route markings and markers is to provide to the pilot by day and, if necessary, by night, visual cues to guide movement along the air taxi-route.

Application

- 5.2.14.1 The centre line of a helicopter air taxi-route shall be identified with markers or markings.

Location

- 5.2.14.2 A helicopter air taxi-route centre line marking or flush in-ground centre line marker shall be located along the centre line of the helicopter air taxi-route.

Characteristics

- 5.2.14.3 A helicopter air taxi-route centre line, when on a paved surface, shall be marked with a continuous yellow line 15 cm in width.
- 5.2.14.4 A helicopter air taxi-route centre line, when on an unpaved surface that will not accommodate painted markings, shall be marked with flush in-ground 15-cm-wide and approximately 1.5 m in length yellow markers, spaced at intervals of not more than 30 m on straight sections and not more than 15 m on curves, with a minimum of four equally spaced markers per section.
- 5.2.14.5 If the helicopter air taxi-route is to be used at night, markers shall be either internally illuminated or retroreflective.

- 5.2.15 Helicopter stand markings

Note. — The objective of helicopter stand markings is to provide to the pilot a visual indication of: an area that is free of obstacles and in which permitted manoeuvring, and all necessary ground functions, may take place; identification, mass and D-value limitations, when required; and guidance for manoeuvring and positioning of the helicopter within the stand.

Application

- 5.2.15.1 A helicopter stand perimeter marking shall be provided.
- 5.2.15.2 A helicopter stand shall be provided with the appropriate TDPM. See Figure-5-8.
- 5.2.15.3 Alignment lines and lead-in/lead-out lines shall be provided on a helicopter stand.

Note 1. — See Chapter 3, Figures 3.5 to 3.9.

Note 2. — Helicopter stand identification markings may be provided where there is a need to identify individual stands.

Note 3. — Additional markings relating to stand size may be provided. See the ICAO Heliport Manual (Doc 9261).

Location

- 5.2.15.4 The TDPM, alignment lines and lead-in/lead-out lines shall be located such that every part of the helicopter can be contained within the helicopter stand during positioning and permitted manoeuvring.
- 5.2.15.5 Alignment lines and lead-in/lead-out lines shall be located as shown in Figure 5-9.

Characteristics

- 5.2.15.6 A helicopter stand perimeter marking shall consist of a continuous yellow line and have a line width of 15 cm.
- 5.2.15.7 The TDPM shall have the characteristics described in Section 5.2.9 above.
- 5.2.15.8 Alignment lines and lead-in/lead-out lines shall be continuous yellow lines and have a width of 15 cm.
- 5.2.15.9 Curved portions of alignment lines and lead-in/lead-out lines shall have radii appropriate to the most demanding helicopter type the helicopter stand is intended to serve.
- 5.2.15.10 Stand identification markings shall be marked in a contrasting colour so as to be easily readable.

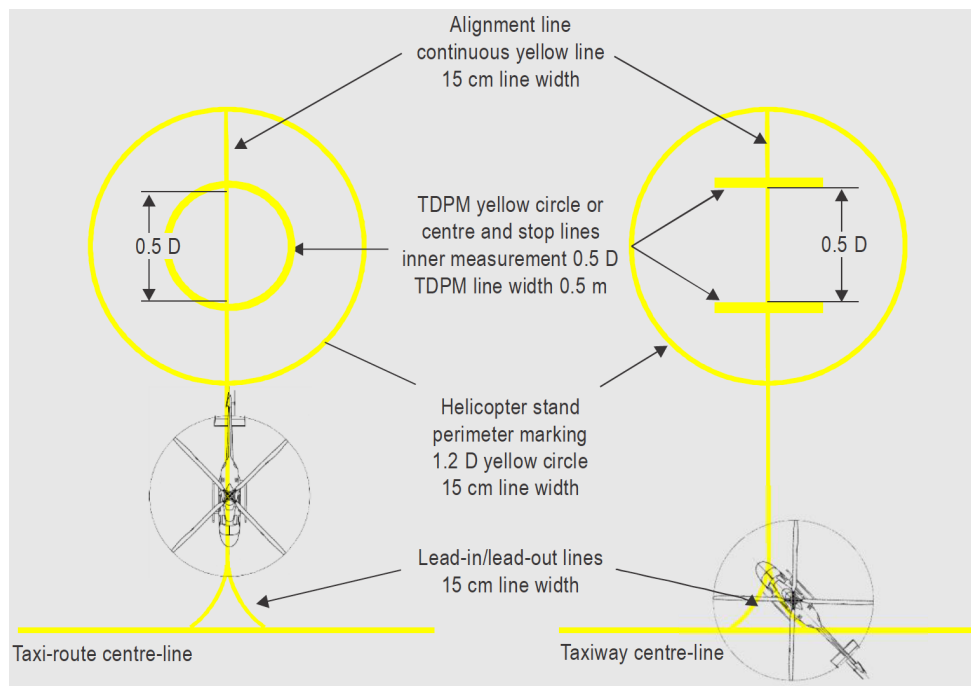

Figure 5-9. Helicopter stand markings

Note 1. — Where it is intended that helicopters proceed in one direction only, arrows indicating the direction to be followed may be added as part of the alignment lines.

Note 2. — The characteristics of markings related to the stand size and alignment and lead-in/lead-out lines are illustrated in Figure 5-10. Examples of stands and their markings can be seen in Chapter 3, Figures 3.5 to 3.9.

5.2.16 Flight path alignment guidance marking

Note. — The objective of flight path alignment guidance marking is to provide the pilot with a visual indication of the available approach and/or departure path direction(s).

Application

5.2.16.1 Flight path alignment guidance marking(s) shall be provided at a heliport where it is desirable and practicable to indicate available approach and/or departure path direction(s).

Note. — The flight path alignment guidance marking can be combined with a flight path alignment guidance lighting system described in 5.3.4

Location

5.2.16.2 The flight path alignment guidance marking shall be located in a straight line along the direction of approach and/or departure path on one or more of the TLOF, FATO, safety area or any suitable surface in the immediate vicinity of the FATO or safety area.

Characteristics

5.2.16.3 A flight path alignment guidance marking shall consist of one or more arrows marked on the TLOF, FATO and/or safety area surface as shown in Figure 5-10. The stroke of the arrow(s) shall be 50 cm in width and at least 3 m in length. When combined with a flight path alignment guidance lighting system it shall take the form shown in Figure 5-10 which includes the scheme for marking “heads of the arrows” which are constant regardless of stroke length.

Note. — In the case of a flight path limited to a single approach direction or single departure direction, the arrow marking may be unidirectional. In the case of a heliport with only a single approach/departure path available, one bidirectional arrow is marked.

5.2.16.4 The markings shall be in a colour which provides good contrast against the background colour of the surface on which they are marked, preferably white.

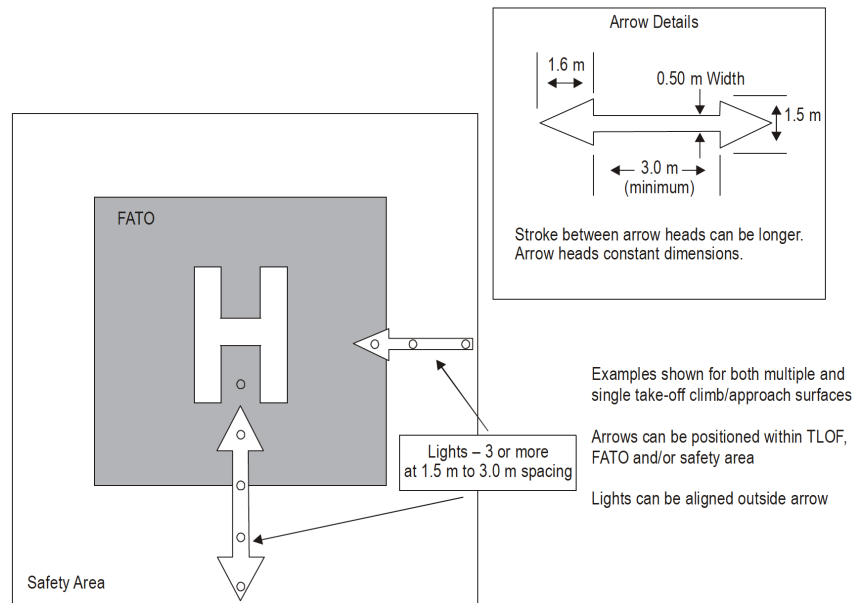

Figure 5-10. Flight path alignment guidance markings and lights

5.3 Lights

5.3.1 General

Note 1. — See CAD 14, Vol. I, 5.3.1, concerning specifications on screening of non- aeronautical ground lights, and design of elevated and inset lights.

Note 2. — In the case of helidecks and heliports located near navigable waters, consideration needs to be given to ensuring that aeronautical ground lights do not cause confusion to mariners.

Note 3. — As helicopters will generally come very close to extraneous light sources, it is particularly important to ensure that, unless such lights are navigation lights exhibited in accordance with international regulations, they are screened or located so as to avoid direct and reflected glare.

Note 4. — Systems addressed in sections 5.3.4, 5.3.6, 5.3.7 and 5.3.8 are designed to provide effective lighting cues based on night conditions. Where lights are to be used in conditions other than night (i.e. day or twilight), it may be necessary to increase the intensity of the lighting to maintain effective visual cues by use of a suitable brilliancy control. Guidance is provided in the ICAO Aerodrome Design Manual (Doc 9157), Part 4.

Note 5. — The specifications for marking and lighting of obstacles included in CAD 14, Vol. I, Chapter 6, are equally applicable to heliports and winching areas.

Note 6. — In cases where operations into a heliport are to be conducted at night with night vision imaging systems (NVIS), it is important to establish the compatibility of the NVIS with all heliport lighting through an assessment by the helicopter operator prior to use.

5.3.2 Heliport beacon

Application

5.3.2.1 A heliport beacon shall be provided at a heliport where:

- a) long-range visual guidance is considered necessary and is not provided by other visual means; or
- b) identification of the heliport is difficult due to surrounding lights.

Location

5.3.2.2 The heliport beacon shall be located on or adjacent to the heliport preferably at an elevated position and so that it does not dazzle a pilot at short range.

Note. — Where a heliport beacon is likely to dazzle pilots at short range, it may be switched off during the final stages of the approach and landing.

Characteristics

5.3.2.3 The heliport beacon shall emit repeated series of equispaced short duration white flashes in the format in Figure 5-11.

5.3.2.4 The light from the beacon shall show at all angles of azimuth.

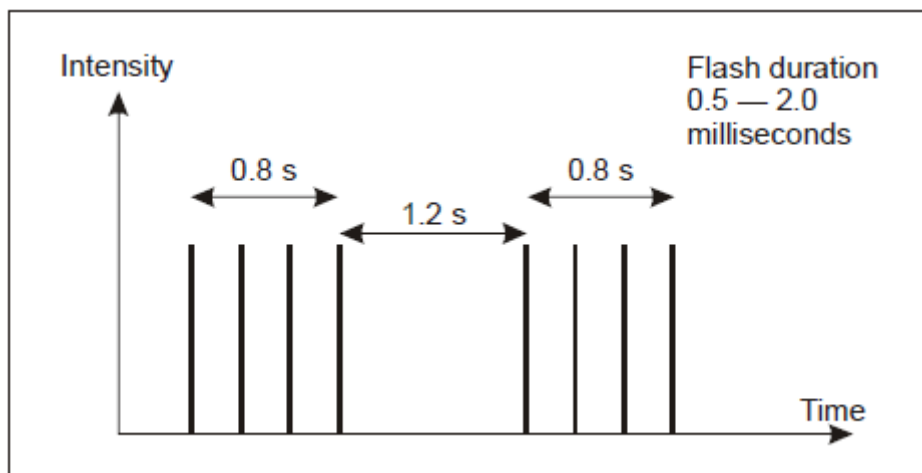

Figure 5-11. Heliport beacon flash characteristics

5.3.2.5 The effective light intensity distribution of each flash shall be as shown in Figure 5-12, Illustration 1.

Note. — Where brilliancy control is desired, settings of 10 per cent and 3 per cent have been found to be satisfactory. In addition, shielding may be necessary to ensure that pilots are not dazzled during the final stages of the approach and landing.

5.3.3 Approach lighting system

Application

5.3.3.1 An approach lighting system should be provided at a heliport where it is desirable and practicable to indicate a preferred approach direction.

Location

5.3.3.2 The approach lighting system shall be located in a straight line along the preferred direction of approach.

Characteristics

5.3.3.3 An approach lighting system shall consist of a row of three lights spaced uniformly at 30 m intervals and of a crossbar 18 m in length at a distance of 90 m from the perimeter of the FATO as shown in Figure 5-13. The lights forming the crossbar shall be as nearly as practicable in a horizontal straight line at right angles to, and bisected by, the line of the centre line lights and spaced at 4.5 m intervals. Where there is the need to make the final approach course more conspicuous, additional lights spaced uniformly at 30 m intervals shall be added beyond the crossbar. The lights beyond the crossbar may be steady or sequenced flashing, depending upon the environment.

Note. — *Sequenced flashing lights may be useful where identification of the approach lighting system is difficult due to surrounding lights.*

5.3.3.4 The steady lights shall be omnidirectional white lights.

5.3.3.5 Sequenced flashing lights shall be omnidirectional white lights.

5.3.3.6 The flashing lights shall have a flash frequency of one per second and their light distribution shall be as shown in Figure 5-12, Illustration 3. The flash sequence shall commence from the outermost light and progress towards the crossbar.

5.3.3.7 A suitable brilliancy control shall be incorporated to allow for adjustment of light intensity to meet the prevailing conditions.

Note. — *The following intensity settings have been found suitable:*

- a) *steady lights — 100 per cent, 30 per cent and 10 per cent; and*
- b) *flashing lights — 100 per cent, 10 per cent and 3 per cent.*

Elevation	
10°	250 cd*
7°	750 cd*
4°	1 700 cd*
2 1/2°	2 500 cd*
1 1/2°	2 500 cd*
0°	1 700 cd*
-180° Azimuth	+180°

(white light)

* Effective intensity

Illustration 1 — Heliport beacon

Elevation	
15°	25 cd
9°	250 cd
6°	350 cd
5°	350 cd
2°	250 cd
0°	25 cd
-180° Azimuth	+180°

(white light)

Illustration 2 — Approach light steady burning

Elevation	
15°	250 cd*
9°	2 500 cd*
6°	3 500 cd*
5°	3 500 cd*
2°	2 500 cd*
0°	250 cd*
-180° Azimuth	+180°

(white light)

* Effective intensity

Illustration 3 — Approach light flashing

Elevation	
30°	10 cd
25°	50 cd
20°	100 cd
10°	
3°	100 cd
0°	10 cd
-180° Azimuth	+180°

Illustration 4 — Final approach and take-off area lights and aiming point lights

Elevation (E)	
20° < E ≤ 90°	3 cd
13° < E ≤ 20°	8 cd
10° < E ≤ 13°	15 cd
5° < E ≤ 10°	30 cd
2° ≤ E ≤ 5°	15 cd
-180° Azimuth	+180°

(green or white light)

Note.— Additional values may be required in the case of installations requiring identification by means of the lights at an elevation of less than two degrees.

Illustration 5 — TLOF perimeter lights and flight path alignment guidance lighting system

Elevation	
90°	55 cd/m ²
60°	55 cd/m ²
40°	50 cd/m ²
30°	45 cd/m ²
20°	30 cd/m ²
10°	15 cd/m ²
0°	5 cd/m ²
-180° Azimuth	+180°

(green light)

Illustration 6 — Touchdown and lift-off area luminescent panels

Figure 5-12 – Isocandela diagrams

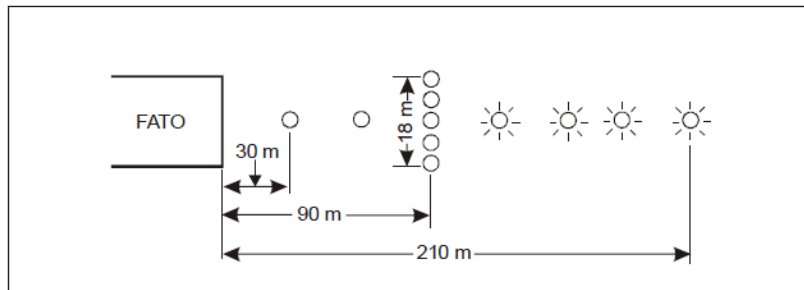

Figure 5-13 – Approach lighting system

5.3.4 Flight path alignment guidance lighting system

Application

5.3.4.1 Flight path alignment guidance lighting system(s) should be provided at a heliport where it is desirable and practicable to indicate available approach and/or departure path direction(s).

Note. — The flight path alignment guidance lighting can be combined with the flight path alignment guidance marking described in 5.2.16.

Location

5.3.4.2 The flight path alignment guidance lighting system shall be in a straight line along the direction(s) of approach and/or departure path on one or more of the TLOF, FATO, safety area or any suitable surface in the immediate vicinity of the FATO, TLOF or safety area.

5.3.4.3 If combined with a flight path alignment guidance marking, as far as is practicable the lights shall be located inside the “arrow” markings.

Characteristics

5.3.4.4 A flight path alignment guidance lighting system shall consist of a row of three or more lights spaced uniformly with a total minimum distance of 6 m. Intervals between lights shall not be less than 1.5 m and shall not exceed 3 m. Where space permits, there shall be 5 lights. (See Figure 5-10).

Note. — The number of lights and spacing between these lights may be adjusted to reflect the space available. If more than one flight path alignment system is used to indicate available approach and/or departure path direction(s), the characteristics for each system are typically kept the same. (See Figure 5-10)

5.3.4.5 The lights shall be steady omnidirectional inset white lights.

5.3.4.6 The distribution of the lights shall be as indicated in Figure 5-12, Illustration 5.

5.3.4.7 A suitable control shall be incorporated to allow for adjustment of light intensity to meet the prevailing conditions and to balance the flight path alignment guidance lighting system with other heliport lights and general lighting that may be present around the heliport.

5.3.5 Visual alignment guidance system

Note. — The objective of a visual alignment guidance system is to provide conspicuous and discrete cues to assist the pilot to attain and maintain a specified approach track to a heliport. Guidance on suitable visual alignment guidance systems is given in the ICAO Heliport Manual (Doc 9261).

Application

5.3.5.1 A visual alignment guidance system shall be provided to serve the approach to a heliport where one or more of the following conditions exist, especially at night:

- a) obstacle clearance, noise abatement or traffic control procedures require a particular direction to be flown;
- b) the environment of the heliport provides few visual surface cues; and
- c) it is physically impracticable to install an approach lighting system.

5.3.6 Visual approach slope indicator

Note. — The objective of a visual approach slope indicator is to provide conspicuous and discrete colour cues, within a specified elevation and azimuth, to assist the pilot to attain and maintain the approach slope to a desired position within a FATO. Guidance on suitable visual approach slope indicators is given in the ICAO Heliport Manual (Doc 9261).

Application

5.3.6.1 A visual approach slope indicator shall be provided to serve the approach to a heliport, whether or not the heliport is served by other visual approach aids or by non-visual aids, where one or more of the following conditions exist, especially at night:

- a) obstacle clearance, noise abatement or traffic control procedures require a particular slope to be flown;
- b) the environment of the heliport provides few visual surface cues; and
- c) the characteristics of the helicopter require a stabilised approach.

5.3.7 FATO lighting systems for onshore surface-level heliports

Note. — The objective of a FATO lighting system for onshore surface-level heliports is to provide to the pilot operating at night an indication of the shape, location and extent of the FATO.

Application

5.3.7.1 Where a FATO with a solid surface is established at a surface-level heliport intended for use at night, FATO lights shall be provided except that they may be omitted where the FATO and the TLOF are nearly coincidental or the extent of the FATO is self-evident.

Location

- 5.3.7.2 FATO lights shall be placed along the edges of the FATO. The lights shall be uniformly spaced as follows:
- a) for an area in the form of a square or rectangle, at intervals of not more than 50 m with a minimum of four lights on each side including a light at each corner; and
 - b) for any other shaped area, including a circular area, at intervals of not more than 5 m with a minimum of ten lights.

Characteristics

- 5.3.7.3 FATO lights shall be fixed omnidirectional lights showing white. Where the intensity of the lights is to be varied, the lights shall show variable white.
- 5.3.7.4 The light distribution of FATO lights shall be as shown in Figure 5-12, Illustration 4.
- 5.3.7.5 The lights shall not exceed a height of 25 cm and shall be inset when a light extending above the surface would endanger helicopter operations. Where a FATO is not meant for lift-off or touchdown, the lights shall not exceed a height of 25 cm above ground level.

5.3.8 Aiming point lights

Note. — The objective of aiming point lights is to provide a visual cue indicating to the pilot by night the preferred approach/departure direction, the point to which the helicopter approaches to a hover before positioning to a TLOF where a touchdown can be made, and that the surface of the FATO is not intended for touchdown.

Application

- 5.3.8.1 Where an aiming point marking is provided at a heliport intended for use at night, aiming point lights shall be provided.

Location

- 5.3.8.2 Aiming point lights shall be collocated with the aiming point marking.

Characteristics

- 5.3.8.3 Aiming point lights shall form a pattern of at least six omnidirectional white lights as shown in Figure 5-7. The lights shall be inset when a light extending above the surface could endanger helicopter operations.
- 5.3.8.4 The light distribution of aiming point lights shall be as shown in Figure 5-12, Illustration 4.

5.3.9 TLOF lighting system

Note. — *The objective of a TLOF lighting system is to provide illumination of the TLOF and required elements within. For a TLOF located in a FATO, the objective is to provide discernibility to the pilot, on a final approach, of the TLOF and required elements within; while for a TLOF located on an elevated heliport, shipboard heliport or helideck, the objective is visual acquisition from a defined range and to provide sufficient shape cues to permit an appropriate approach angle to be established.*

Application

5.3.9.1 A TLOF lighting system shall be provided at a heliport intended for use at night.

Note. — *Where a TLOF is located in a stand, the objective may be met with the use of ambient lighting or stand floodlighting.*

5.3.9.2 For a surface-level heliport, lighting for the TLOF in a FATO shall consist of one or more of the following:

- a) perimeter lights;
- b) floodlighting;
- c) arrays of segmented point source lighting (ASPSL) or luminescent panel (LP) lighting to identify the TLOF when a) and b) are not practicable and FATO lights are available.

5.3.9.3 For an elevated heliport, shipboard heliport or helideck, lighting for the TLOF in a FATO shall consist of:

- a) perimeter lights; and
- b) ASPSL and/or LPs to identify the TDPM and/or floodlighting to illuminate the TLOF.

Note 1. — *At elevated heliports, shipboard heliports and helidecks, surface texture cues within the TLOF are essential for helicopter positioning during the final approach and landing. Such cues can be provided using various forms of lighting (ASPSL, LP, floodlights or a combination of these lights, etc.) in addition to perimeter lights. Best results have been demonstrated by the combination of perimeter lights and ASPSL in the form of encapsulated strips of light emitting diodes (LEDs) and inset lights to identify the TDPM and heliport identification markings.*

5.3.9.4 TLOF ASPSL and/or LPs to identify the TDPM and/or floodlighting shall be provided at a surface-level heliport intended for use at night when enhanced surface texture cues are required.

Location

- 5.3.9.5 TLOF perimeter lights shall be placed along the edge of the area designated for use as the TLOF or within a distance of 1.5 m from the edge. Where the TLOF is a circle, the lights shall be:
- a) located on straight lines in a pattern which will provide information to pilots on drift displacement; and
 - b) where a) is not practicable, evenly spaced around the perimeter of the TLOF at the appropriate interval, except that over a sector of 45 degrees the lights shall be spaced at half spacing.
- 5.3.9.6 TLOF perimeter lights shall be uniformly spaced at intervals of not more than 3 m for elevated heliports and helidecks and not more than 5 m for surface-level heliports. There shall be a minimum number of four lights on each side including a light at each corner. For a circular TLOF where lights are installed in accordance with 5.3.9.5 b), there shall be a minimum of fourteen lights.
- Note. — Guidance on this issue is contained in the ICAO Heliport Manual (Doc 9261).*
- 5.3.9.7 The TLOF perimeter lights shall be installed at an elevated heliport or fixed helideck such that the pattern cannot be seen by the pilot from below the elevation of the TLOF.
- 5.3.9.8 The TLOF perimeter lights shall be installed on a moving helideck or shipboard heliport such that the pattern cannot be seen by the pilot from below the elevation of the TLOF when the helideck or shipboard heliport is level.
- 5.3.9.9 On surface-level heliports, ASPSL or LPs, if provided to identify the TLOF, shall be placed along the marking designating the edge of the TLOF. Where the TLOF is a circle, they shall be located on straight lines circumscribing the area.
- 5.3.9.10 On surface-level heliports, the minimum number of LPs on a TLOF shall be nine. The total length of LPs in a pattern shall not be less than 50 per cent of the length of the pattern. There shall be an odd number with a minimum number of three panels on each side of the TLOF including a panel at each corner. LPs shall be uniformly spaced with a distance between adjacent panel ends of not more than 5 m on each side of the TLOF.
- 5.3.9.11 When LPs are used on an elevated heliport or helideck to enhance surface texture cues, the panels shall not be placed adjacent to the perimeter lights. They shall be placed around a TDPM or coincident with heliport identification marking.
- 5.3.9.12 TLOF floodlights shall be located so as to avoid glare to pilots in flight or to personnel working on the area. The arrangement and aiming of floodlights shall be such that shadows are kept to a minimum.

Note. — ASPSL and LPs used to designate the TDPM and/or heliport identification marking have been shown to provide enhanced surface texture cues when compared to low-level floodlights. Due to the risk of misalignment, if floodlights are used, there will be a need for them to be checked periodically to ensure they remain within the specifications contained within 5.3.9.

Characteristics

- 5.3.9.13 The TLOF perimeter lights shall be fixed omnidirectional lights showing green.
- 5.3.9.14 At a surface-level heliport, ASPSL or LPs shall emit green light when used to define the perimeter of the TLOF.
- 5.3.9.15 The chromaticity and luminance of colours of LPs shall conform to CAD 14, Vol. I, Appendix 1, 3.4.
- 5.3.9.16 An LP shall have a minimum width of 6 cm. The panel housing shall be the same colour as the marking it defines.
- 5.3.9.17 For a surface-level or elevated heliport, the TLOF perimeter lights located in a FATO shall not exceed a height of 5 cm and shall be inset when a light extending above the surface could endanger helicopter operations.
- 5.3.9.18 For a helideck or shipboard heliport, the TLOF perimeter lights shall not exceed a height of 5 cm, or for a FATO/TLOF, 15 cm.
- 5.3.9.19 When located within the safety area of a surface-level or elevated heliport, the TLOF floodlights shall not exceed a height of 25 cm.
- 5.3.9.20 For a helideck or shipboard heliport, the TLOF floodlights shall not exceed a height of 5 cm, or for a FATO/TLOF, 15 cm.
- 5.3.9.21 The LPs shall not extend above the surface by more than 2.5 cm.
- 5.3.9.22 The light distribution of the perimeter lights shall be as shown in Figure 5-12, Illustration 5.
- 5.3.9.23 The light distribution of the LPs shall be as shown in Figure 5-12, Illustration 6.
- 5.3.9.24 The spectral distribution of TLOF floodlights shall be such that the surface and obstacle markings can be correctly identified.
- 5.3.9.25 The average horizontal illuminance of the floodlighting shall be at least 10 lux, with a uniformity ratio (average to minimum) of not more than 8:1 measured on the surface of the TLOF.
- 5.3.9.26 Lighting used to identify the TDPC should comprise a segmented circle of omnidirectional ASPSL strips showing yellow. The segments should consist of

ASPSL strips, and the total length of the ASPSL strips should not be less than 50 per cent of the circumference of the circle.

- 5.3.9.27 If utilised, the heliport identification marking lighting should be omnidirectional showing green.

5.3.10 Helicopter stand floodlighting

Note. — *The objective of helicopter stand floodlighting is to provide illumination of the stand surface and associated markings to assist the manoeuvring and positioning of a helicopter and facilitation of essential operations around the helicopter.*

Application

- 5.3.10.1 Helicopter stand floodlighting shall be provided on a helicopter stand intended to be used at night.

Note. — *Guidance on stand floodlighting is given in the apron floodlighting section in the ICAO Aerodrome Design Manual (Doc 9157), Part 4.*

Location

- 5.3.10.2 Helicopter stand floodlights shall be located so as to provide adequate illumination, with a minimum of glare to the pilot of a helicopter in flight and on the ground, and to personnel on the stand. The arrangement and aiming of floodlights shall be such that a helicopter stand receives light from two or more directions to minimise shadows.

Characteristics

- 5.3.10.3 The spectral distribution of stand floodlights shall be such that the colours used for surface and obstacle marking can be correctly identified.

- 5.3.10.4 Horizontal and vertical illuminance shall be sufficient to ensure that visual cues are discernible for required manoeuvring and positioning, and essential operations around the helicopter can be performed expeditiously without endangering personnel or equipment.

5.3.11 Winching area floodlighting

Note. — *The objective of winching area floodlighting is to provide illumination of the surface and obstacles, and visual cues to assist a helicopter to be positioned over, and retained within, an area from which a passenger or equipment can be lowered or raised.*

Application

- 5.3.11.1 Winching area floodlighting shall be provided at a winching area intended for use at night.

Location

- 5.3.11.2 Winching area floodlights shall be located so as to avoid glare to pilots in flight or to personnel working on the area. The arrangement and aiming of floodlights shall be such that shadows are kept to a minimum.

Characteristics

- 5.3.11.3 The spectral distribution of winching area floodlights shall be such that the surface and obstacle markings can be correctly identified.
- 5.3.11.4 The average horizontal illuminance shall be at least 10 lux, measured on the surface of the winching area.

- 5.3.12 Taxiway lights

Note. — *The specifications for taxiway centre line lights and taxiway edge lights in CAD 14, Vol. I, 5.3.17 and 5.3.18, are equally applicable to taxiways intended for ground taxiing of helicopters.*

- 5.3.13 Visual aids for denoting obstacles outside and below the obstacle limitation surface

Note. — *Arrangements for an aeronautical study of objects outside the obstacle limitation surface and for other objects are addressed in CAD 14, Vol. I, Chapter 4.*

- 5.3.13.1 Where an aeronautical study indicates that obstacles in areas outside and below the boundaries of the obstacle limitation surface established for a heliport constitute a hazard to helicopters, they shall be marked and lit, except that the marking may be omitted when the obstacle is lighted with high-intensity obstacle lights by day.

- 5.3.13.2 Where an aeronautical study indicates that overhead wires or cables crossing a river, waterway, valley or highway constitute a hazard to helicopters, they shall be marked, and their supporting towers marked and lit.

- 5.3.14 Floodlighting of obstacles

Application

- 5.3.14.1 At a heliport intended for use at night, obstacles shall be floodlighted if it is not possible to display obstacle lights on them.

Location

- 5.3.14.2 Obstacle floodlights shall be arranged so as to illuminate the entire obstacle and as far as practicable in a manner so as not to dazzle pilots.

Characteristics

- 5.3.14.3 Obstacle floodlighting shall be such as to produce a luminance of at least 10 cd/m².

6 Heliport Emergency Response

6.1 Heliport emergency planning

Introductory Note. — Heliport emergency planning is the process of preparing a heliport to cope with an emergency that takes place at the heliport or in its vicinity. Examples of emergencies include crashes on or off the heliport, medical emergencies, dangerous goods occurrences, fires and natural disasters. The purpose of heliport emergency planning is to minimise the impact of an emergency by saving lives and maintaining helicopter operations. The heliport emergency plan sets out the procedures for coordinating the response of heliport agencies or services (air traffic services unit, firefighting services, heliport administration, medical and ambulance services, aircraft operators, security services and police) and the response of agencies in the surrounding community (fire departments, police, medical and ambulance services, hospitals, military, and harbour patrol or coast guard) that could be of assistance in responding to the emergency.

- 6.1.1 A heliport emergency plan shall be established commensurate with the helicopter operations and other activities conducted at the heliport.
- 6.1.2 The plan shall identify agencies which could be of assistance in responding to an emergency at the heliport or in its vicinity.
- 6.1.3 The heliport emergency plan shall provide for the coordination of the actions to be taken in the event of an emergency occurring at a heliport or in its vicinity.
- 6.1.4 Where an approach/departure path at a heliport is located over water, the plan shall identify which agency is responsible for coordinating rescue in the event of a helicopter ditching and indicate how to contact that agency.
- 6.1.5 The plan shall include, as a minimum, the following information:
 - a) the types of emergencies planned for;
 - b) how to initiate the plan for each emergency specified;
 - c) the name of agencies on and off the heliport to contact for each type of emergency with telephone numbers or other contact information;
 - d) the role of each agency for each type of emergency;
 - e) a list of pertinent on-heliport services available with telephone numbers or other contact information;
 - f) copies of any written agreements with other agencies for mutual aid and the provision of emergency services; and
 - g) a grid map of the heliport and its immediate vicinity.
- 6.1.6 All agencies identified in the plan shall be consulted about their role in the plan.

6.1.7 The plan shall be reviewed and the information in it updated at least yearly or, if deemed necessary, after an actual emergency, so as to correct any deficiency found during an actual emergency.

6.1.8 A test of the emergency plan shall be carried out at least once every three years.

6.2 Rescue and firefighting

Introductory Note. — It is important this section be read in conjunction with the appropriate detailed guidance on rescue and firefighting options given in the ICAO Heliport Manual (Doc 9261).

Provisions described in this section are intended to address incidents or accidents within the heliport response area only. No dedicated firefighting provisions are included for helicopter accidents or incidents that may occur outside the response area, such as on an adjacent roof near an elevated heliport.

Complementary agents are ideally dispensed from one or two extinguishers (although more extinguishers may be permitted where high volumes of an agent are specified, e.g. H3 operations). The discharge rate of complementary agents needs to be selected for optimum effectiveness of the agent used. When selecting dry chemical powders for use with foam, care needs to be exercised to ensure compatibility. Complementary agents need to comply with the appropriate specifications of the International Organisation for Standardisation (ISO).

Where a fixed monitor system (FMS) is installed, trained monitor operators, where provided, are positioned on at least the upwind location to ensure primary media is directed to the seat of the fire. For a ring-main system (RMS) practical testing has indicated that these solutions are only guaranteed to be fully effective for TLOFs up to 20 m diameter. If the TLOF is greater than 20 m, an RMS shall not be considered unless supplemented by other means to distribute primary media (e.g. additional pop-up nozzles installed in the centre of the TLOF).

The International Convention for the Safety of Life at Sea (SOLAS) sets forth provisions on rescue and firefighting (RFF) arrangements for purpose-built and non-purpose-built shipboard heliports in SOLAS regulations II 2/18, II-2-Helicopter Facilities, and the SOLAS Fire Safety Systems Code.

It may therefore be assumed that this chapter does not include RFF arrangements for purpose built or non-purpose-built shipboard heliports or for winching areas.

6.2.1 Applicability

6.2.1.1 The following specifications shall apply to new builds or replacement of existing systems or part thereof from 1 January 2023: 6.2.2.1, 6.2.3.3, 6.2.3.4, 6.2.3.6, 6.2.3.7, 6.2.3.9, 6.2.3.10, 6.2.3.12, 6.2.3.13 and 6.2.4.2.

Note. — For areas for the exclusive use of helicopters at aerodromes primarily for the use of aeroplanes, distribution of extinguishing agents, response time, rescue equipment and personnel have not been considered in this section. See CAD 14, Vol. I, Chapter 9.

6.2.1.2 Rescue and firefighting equipment and services shall be provided at helidecks and at elevated heliports located above occupied structures.

6.2.1.3 A safety risk assessment shall be performed to determine the need for RFF equipment and services at surface-level heliports and elevated heliports located above unoccupied structures.

Note. — Further guidance on factors to inform the safety risk assessment, including staffing models for heliports with only occasional movements and examples of unoccupied areas that may be located beneath elevated heliports, is given in the ICAO Heliport Manual (Doc 9261).

6.2.2 Level of protection provided

6.2.2.1 For the application of primary media, the discharge rate (in litres/minute) applied over the assumed practical critical area (in m²) shall be predicated on a requirement to bring any fire which may occur on the heliport under control within one minute, measured from activation of the system at the appropriate discharge rate.

Practical critical area calculation where primary media is applied as a solid stream

Note. — This section is not applicable to helidecks regardless of how primary media is being delivered.

6.2.2.2 The practical critical area shall be calculated by multiplying the helicopter fuselage length (m) by the helicopter fuselage width (m) plus an additional width factor (W1) of 4 m. Categorisation from H0 to H3 shall be determined on the basis of the fuselage dimensions in Table 6-1.

Note 1. — For helicopters which exceed one or both of the dimensions for a category H3 heliport, it will be necessary to recalculate the level of protection using practical critical area assumptions based on the actual fuselage length and the actual fuselage width of the helicopter plus an additional width factor (W1) of 6 m.

Note 2. — The practical critical area may be considered on a helicopter type-specific basis by using the formula in 6.2.2.2. Guidance on practical critical area in relation to the heliport firefighting category is given in the ICAO Heliport Manual (Doc 9261) where a discretionary 10 per cent tolerance on fuselage dimension “upper limits” is applied.

Category (1)	Maximum fuselage length (2)	Maximum fuselage width (3)
H0	up to but not including 8 m	1.5
H1	from 8 m up to but not including 12 m	2
H2	from 12 m up to but not including 16 m	2.5
H3	from 16 m up to 20 m	3

Table 6-1. Heliport firefighting category

Practical critical area calculation where primary media is applied in a dispersed pattern

6.2.2.3 For heliports, except helidecks, the practical critical area shall be based on an area contained within the heliport perimeter, which always includes the TLOF, and to the extent that it is load-bearing, the FATO.

6.2.2.4 For helidecks, the practical critical area shall be based on the largest circle capable of being accommodated within the TLOF perimeter.

Note. — Paragraph 6.2.2.4 is applied for the practical critical area calculation for helidecks regardless of how primary media is being delivered.

6.2.3 Extinguishing agents

Note 1. — Throughout section 6.2.3, the discharge rate of a performance level B foam is assumed to be based on an application rate of 5.5 L/min/m², and for a performance level C foam and for water, is assumed to be based on an application rate of 3.75 L/min/m². These rates may be reduced if, through practical testing, a demonstrates that the objectives of 6.2.2.1 can be achieved for a specific foam use at a lower discharge rate (L/min).

Note 2. — Information on the required physical properties and fire extinguishing performance criteria needed for a foam to achieve an acceptable performance level B or C rating is given in the ICAO Airport Services Manual (Doc 9137), Part 1.

Surface level heliports with primary media applied as a solid stream using a portable foam application system (PFAS)

Note. — Except for a limited-sized surface-level heliport, the assumption is made that foam dispensing equipment will be transported to the incident or accident location on an appropriate vehicle (a PFAS).

6.2.3.1 Where a rescue and firefighting service (RFFS) is provided at a surface-level heliport, the amount of primary media and complementary agents shall be in accordance with Table 6 2.

Note. — The minimum discharge duration in Table 6-2 is assumed to be two minutes. However, if the availability of back-up specialist fire services is remote

from the heliport, consideration may need to be given to increasing the discharge duration from two minutes to three minutes.

Category (1)	Foam meeting performance level B		Foam meeting performance level C		Complementary agents	
	Water (L) (2)	Discharge rate foam solution (L/min) (3)	Water (L) (4)	Discharge rate foam solution (L/min) (5)	Dry chemical powder (kg) (6)	Gaseous media (kg) (7)
H0	500	250	330	165	23	9
H1	800	400	540	270	23	9
H2	1 200	600	800	400	45	18
H3	1 600	800	1 100	550	90	36

Table 6-2. Minimum usable amounts of extinguishing agents for surface-level heliports

Elevated heliports with primary media applied as a solid stream using a fixed foam application system (FFAS)

Note. — The assumption is made that primary media (foam) will be delivered through a fixed foam application system such as an FMS.

6.2.3.2 Where an RFFS is provided at an elevated heliport, the amount of foam media and complementary agents shall be in accordance with Table 6-3.

Note 1. — The minimum discharge duration in Table 6-3 is assumed to be five minutes.

Note 2. — For guidance on the provision of additional hand-controlled foam branches for the application of aspirated foam, see the ICAO Heliport Manual (Doc 9261).

Category (1)	Foam meeting performance level B		Foam meeting performance level C		Complementary agents	
	Water (L) (2)	Discharge rate foam solution (L/min) (3)	Water (L) (4)	Discharge rate foam solution (L/min) (5)	Dry chemical powder (kg) (6)	Gaseous media (kg) (7)
H0	1 200	250	825	165	23	9
H1	2 000	400	1 350	270	23	9
H2	3 000	600	2 000	400	45	18
H3	4 000	800	2 750	550	90	36

Table 6-3. Minimum usable amounts of extinguishing agents for elevated heliports

Elevated heliports/limited-sized surface-level heliports with primary media applied in a dispersed pattern through an FFAS — a solid-plate heliport

6.2.3.3 The amount of water required for foam production shall be predicated on the practical critical area (m²) multiplied by the appropriate application rate (L/min/m²), giving a discharge rate for foam solution (in L/min). The discharge rate shall be multiplied by the discharge duration to calculate the amount of water needed for foam production.

6.2.3.4 The discharge duration shall be at least three minutes.

6.2.3.5 Complementary media shall be in accordance with Table 6-3, for H2 operations.

Note. — For helicopters with a fuselage length greater than 16 m and/or a fuselage width greater than 2.5 m, complementary media in Table 6-3 for H3 operations may be considered.

Purpose-built elevated heliports/limited-sized surface-level heliports with primary media applied in a dispersed pattern through a fixed application system (FAS) — a passive fire retarding surface with water-only deck integrated firefighting system (DIFFS)

6.2.3.6 The amount of water required shall be predicated on the practical critical area (m²) multiplied by the appropriate application rate (3.75 L/min/m²) giving a discharge rate for water (in L/min). The discharge rate shall be multiplied by the discharge duration to determine the total amount of water needed.

6.2.3.7 The discharge duration shall be at least two minutes.

6.2.3.8 Complementary media shall be in accordance with Table 6-3 for H2 operations.

Note. — For helicopters with a fuselage length greater than 16 m and/or a fuselage width greater than 2.5 m, complementary media for H3 operations may be considered.

Purpose-built helidecks with primary media applied in a solid stream or a dispersed pattern through a fixed foam application system (FFAS) — a solid-plate heliport

6.2.3.9 The amount of water required for foam media production shall be predicated on the practical critical area (m²) multiplied by the application rate (L/min/m²) giving a discharge rate for foam solution (in L/min). The discharge rate shall be multiplied by the discharge duration to calculate the amount of water needed for foam production.

6.2.3.10 The discharge duration shall be at least five minutes.

- 6.2.3.11 Complementary media shall be in accordance with Table 6-3 to H0 levels for helidecks up to and including 16.0 m and to H1/H2 levels for helidecks greater than 16.0 m. Helidecks greater than 24 m shall adopt H3 levels.

Note. — For guidance on the provision of additional hand-controlled foam branches for the application of aspirated foam, see the ICAO Heliport Manual (Doc 9261).

Purpose-built helidecks with primary media applied in a dispersed pattern through an FAS — a passive fire-retarding surface with water-only DIFFS

- 6.2.3.12 The amount of water required shall be predicated on the practical critical area (m²) multiplied by the application rate (3.75 L/min/m²) giving a discharge rate for water (in L/min). The discharge rate shall be multiplied by the discharge duration to calculate the amount of water needed.

Note. — Sea-water may be used.

- 6.2.3.13 The discharge duration shall be at least three minutes.

- 6.2.3.14 Complementary media shall be in accordance with Table 6-3 to H0 levels for helidecks up to and including 16.0 m and to H1/H2 levels for helidecks greater than 16.0 m. Helidecks greater than 24 m shall adopt H3 levels.

6.2.4 Response time

- 6.2.4.1 At surface-level heliports, the operational objective of the RFF response shall be to achieve response times not exceeding two minutes in optimum conditions of visibility and surface conditions.

Note. — Response time is considered to be the time between the initial call to the RFFS and the time when the first responding vehicle(s) (the service) is (are) in position to apply foam at a rate of at least 50 per cent of the discharge rate specified in Table 6-2.

- 6.2.4.2 At elevated heliports, limited-sized surface-level heliports and helidecks, the response time for the discharge of primary media at the required application rate shall be 15 seconds measured from system activation. If RFF personnel are needed, they shall be immediately available on or in the vicinity of the heliport while helicopter movements are taking place.

6.2.5 Rescue arrangements

- 6.2.5.1 Rescue arrangements commensurate with the overall risk of the helicopter operation shall be provided at the heliport.

Note. — Guidance on rescue arrangements, e.g. options for rescue and for personal protective equipment to be provided at a heliport, is given in the ICAO Heliport Manual (Doc 9261).



- 6.2.6 Communication and alerting system
- 6.2.6.1 A suitable alerting and/or communication system shall be provided in accordance with the emergency response plan.
- 6.2.7 Personnel
- Note. — The provision of RFF personnel may be determined by use of a task/resource analysis. Guidance is given in the ICAO Heliport Manual (Doc 9261).*
- 6.2.7.1 Where provided, the number of RFF personnel shall be sufficient for the required task.
- 6.2.7.2 Where provided, RFF personnel shall be trained to perform their duties, and maintain their competence.
- 6.2.7.3 Rescue and firefighting personnel shall be provided with protective equipment.
- 6.2.8 Means of escape
- 6.2.8.1 Elevated heliports and helidecks shall be provided with a main access and at least one additional means of escape.
- 6.2.8.2 Access points shall be located as far apart from each other as is practicable.
- Note. — The provision of an alternative means of escape is necessary for evacuation and for access by RFF personnel. The size of an emergency access/egress route may require consideration of the number of passengers and of special operations such as helicopter emergency medical services that require passengers to be carried on stretchers or trolleys.*

7 Appendices

7.1 Appendix 1 – International Standards And Recommended Practices For Instrument Heliports With Non-Precision and/or Precision Approaches And Instrument Departures

1. General

Introductory Note 1. — This CAD contains Standards and Recommended Practices (specifications) that prescribe the physical characteristics and obstacle limitation surfaces to be provided for at heliports, and certain facilities and technical services normally provided at a heliport. It is not intended that these specifications limit or regulate the operation of an aircraft.

Introductory Note 2. — The specifications in this appendix describe additional conditions beyond those found in the main sections of this CAD, that apply to instrument heliports with non-precision and/or precision approaches. All specifications contained within the main chapters of this CAD, are equally applicable to instrument heliports, but with reference to further provisions described in this Appendix.

2. Heliport Data

2.1 Heliport elevation

The elevation of the TLOF and/or the elevation and geoid undulation of each threshold of the FATO (where appropriate) shall be measured and reported to the aeronautical information services to the accuracy of:

- a) one-half metre or foot for non-precision approaches; and
- b) one-quarter metre or foot for precision approaches.

Note. — Geoid undulation must be measured in accordance with the appropriate system of coordinates.

2.2 Heliport dimensions and related information

The following additional data shall be measured or described, as appropriate, for each facility provided on an instrument heliport:

distances to the nearest metre or foot of localiser and glide path elements comprising an instrument landing system (ILS) or azimuth and elevation antenna of a microwave landing system (MLS) in relation to the associated TLOF or FATO extremities.

3. Physical Characteristics

3.1 Surface-level and elevated heliports

Safety areas

A safety area surrounding an instrument FATO shall extend:

- a) laterally to a distance of at least 45 m on each side of the centre line; and

- b) longitudinally to a distance of at least 60 m beyond the ends of the FATO.

Note. — See Figure A-1.

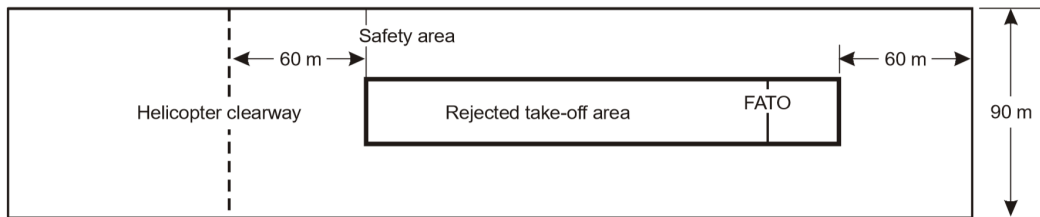

Figure A-1. Safety area for instrument FATO

4. Obstacle Environment

4.1 Obstacle limitation surfaces and sectors

Approach surface

Characteristics. The limits of an approach surface shall comprise:

- a) an inner edge horizontal and equal in length to the minimum specified width of the FATO plus the safety area, perpendicular to the centre line of the approach surface and located at the outer edge of the safety area;
- b) two side edges originating at the ends of the inner edge;
 - 1) for an instrument FATO with a non-precision approach, diverging uniformly at a specified rate from the vertical plane containing the centre line of the FATO;
 - 2) for an instrument FATO with a precision approach, diverging uniformly at a specified rate from the vertical plane containing the centre line of the FATO, to a specified height above FATO, and then diverging uniformly at a specified rate to a specified final width and continuing thereafter at that width for the remaining length of the approach surface; and
- c) an outer edge horizontal and perpendicular to the centre line of the approach surface and at a specified height above the elevation of the FATO.

4.2 Obstacle limitation requirements

4.2.1 The following obstacle limitation surfaces shall be established for an instrument FATO with a non-precision and/or precision approach:

- a) take-off climb surface;
- b) approach surface; and
- c) transitional surfaces.

Note. — See Figure A-2 to A-5.

4.2.2 The slopes of the obstacle limitation surfaces shall not be greater than, and their other dimensions not less than, those specified in Tables A-1 to A-3.

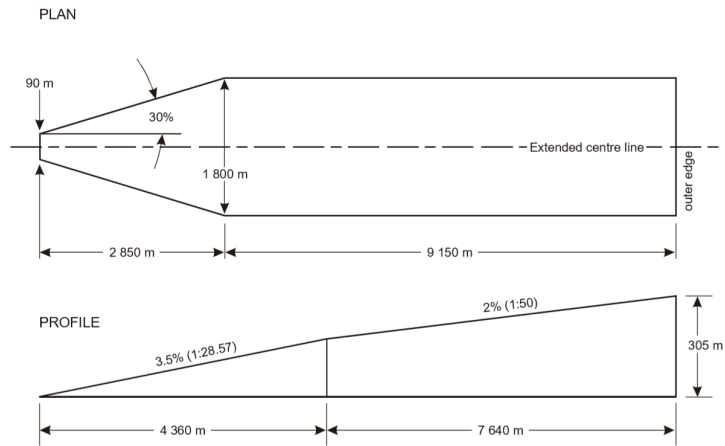

Figure A-2. Take-off climb surface for instrument FATO

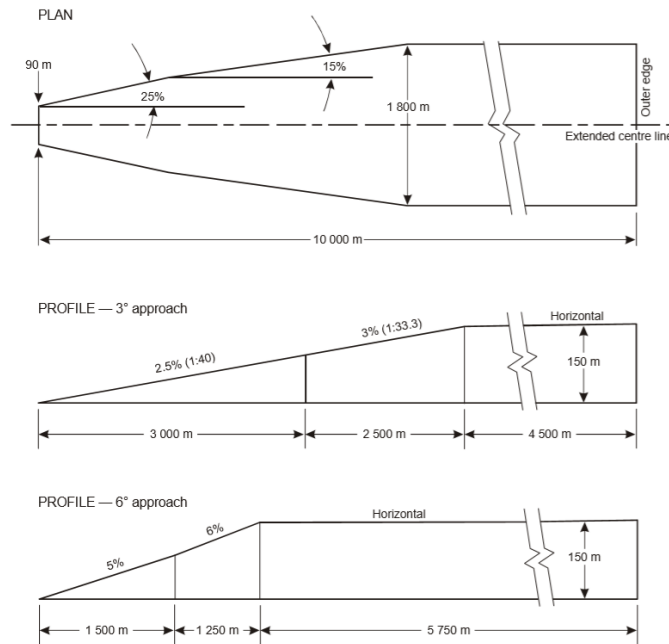

Figure A-3. Approach surface for precision approach FATO

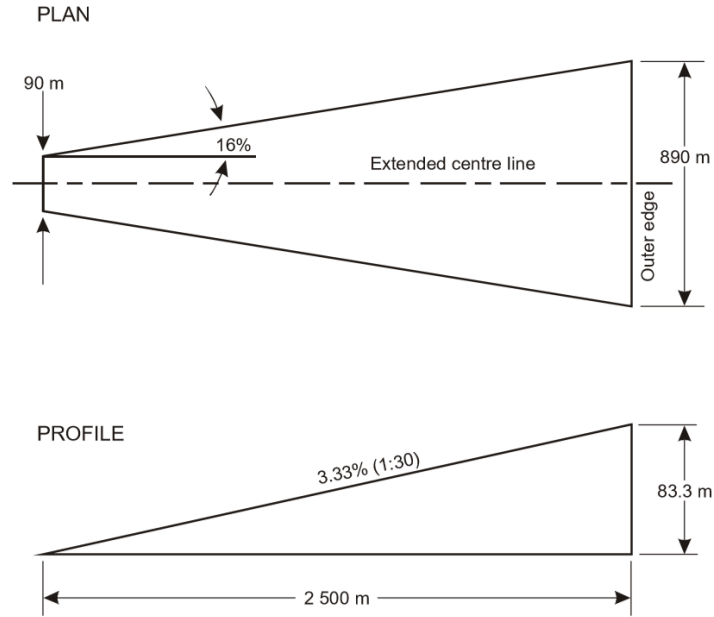
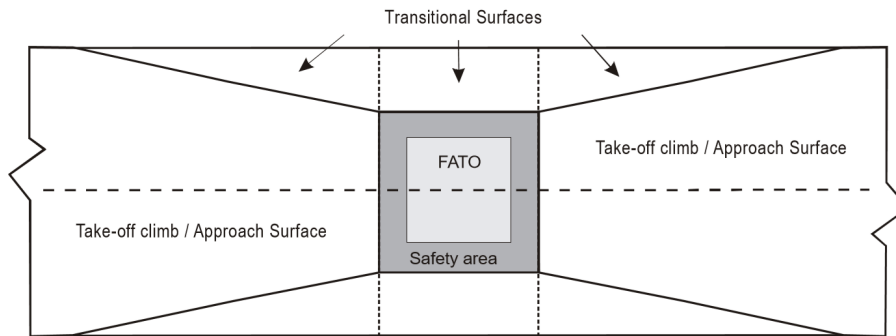

Figure A-4. Approach surface for non-precision approach FATO



Note 1.— For single Take-off climb / Approach Surface. Transition surface extends perpendicular to far side of Safety Area.
Note 2.— Doc 8168, Vol II, Part IV, Helicopters, details further obstacle limitation surface requirements associated with a VSS.

Figure A-5. Transitional surfaces for an instrument FATO with a non-precision and/or precision approach

**Table A-1. Dimensions and slopes of obstacle limitation surfaces
Instrument (non-precision) FATO**

Surfaces and dimensions

APPROACH SURFACE		
Width of inner edge		Width of safety area boundary
Location of inner edge		
First Section		
Divergence	- day - night	16%
Length	- day - night	2 500 m
Outer width	- day - night	890 m
Slope (maximum)		3.33%
Second Section		
Divergence	- day - night	—
Length	- day - night	—
Outer width	- day - night	—
Slope (maximum)		—
Third Section		
Divergence	- day - night	—
Length	- day - night	—
Outer width	- day - night	—
Slope (maximum)		—
TRANSITIONAL		
Slope		20%
Height		45 m

**Table A-2. Dimensions and slopes of obstacle limitation surfaces
Instrument (precision) FATO**

	3° approach				6° approach			
	Height above FATO				Height above FATO			
Surface and dimensions	90 m (300 ft)	60 m (200 ft)	45 m (150 ft)	30 m (100 ft)	90 m (300 ft)	60 m (200 ft)	45 m (150 ft)	30 m (100 ft)
APPROACH SURFACE								
Length of inner edge	90 m	90 m	90 m	90 m	90 m	90 m	90 m	90 m
Distance from end of FATO	60 m	60 m	60 m	60 m	60 m	60 m	60 m	60 m
Divergence each side to height above FATO	25%	25%	25%	25%	25%	25%	25%	25%
Distance to height above FATO	1 745 m	1 163 m	872 m	581 m	870 m	580 m	435 m	290 m
Width at height above FATO	962 m	671 m	526 m	380 m	521 m	380 m	307.5 m	235 m
Divergence to parallel section	15%	15%	15%	15%	15%	15%	15%	15%
Distance to parallel section	2 793 m	3 763 m	4 246 m	4 733 m	4 250 m	4 733 m	4 975 m	1 800 m
Width of parallel section	1 800 m	1 800 m	1 800 m	1 800 m	1 800 m	1 800 m	1 800 m	1 800 m
Distance to outer edge	5 462 m	5 074 m	4 882 m	4 686 m	3 380 m	3 187 m	3 090 m	2 993 m
Width at outer edge	1 800 m	1 800 m	1 800 m	1 800 m	1 800 m	1 800 m	1 800 m	1 800 m
Slope of first section	2.5% (1:40)	2.5% (1:40)	2.5% (1:40)	2.5% (1:40)	5% (1:20)	5% (1:20)	5% (1:20)	5% (1:20)
Length of first section	3 000 m	3 000 m	3 000 m	3 000 m	1 500 m	1 500 m	1 500 m	1 500 m
Slope of second section	3% (1:33.3)	3% (1:33.3)	3% (1:33.3)	3% (1:33.3)	6% (1:16.66)	6% (1:16.66)	6% (1:16.66)	6% (1:16.66)
Length of second section	2 500 m	2 500 m	2 500 m	2 500 m	1 250 m	1 250 m	1 250 m	1 250 m
Total length of surface	10000 m	10 000 m	10000 m	10000 m	8 500 m	8 500 m	8 500 m	8 500 m
TRANSITIONAL								
Slope	14.3%	14.3%	14.3%	14.3%	14.3%	14.3%	14.3%	14.3%
Height	45 m	45 m	45 m	45 m	45 m	45 m	45 m	45 m

**Table A-3. Dimensions and slopes of obstacle limitation surfaces
Straight take-off**

<i>Surfaces and dimensions</i>		<i>Instrument</i>
TAKE-OFF CLIMB		
Width of inner edge		90 m
Location of inner edge		Boundary of end of clearway
First Section		
Divergence	- day - night	30%
Length	- day - night	2 850 m
Outer width	- day - night	1 800 m
Slope (maximum)		3.5%
Second Section		
Divergence	- day - night	parallel
Length	- day - night	1 510 m
Outer width	- day - night	1 800 m
Slope (maximum)		3.5%*
Third Section		
Divergence	- day - night	parallel
Length	- day - night	7 640 m
Outer width	- day - night	1 800 m
Slope (maximum)		2%

* This slope exceeds the maximum mass one-engine-inoperative climb gradient of many helicopters which are currently operating

5. VISUAL AIDS

5.1 Lights

Approach lighting systems

- 5.1.1 Where an approach lighting system is provided for a non-precision FATO, the system shall not be less than 210 m in length.
- 5.1.2 The light distribution of steady lights shall be as indicated in Figure 5-12, Illustration 2 except that the intensity shall be increased by a factor of three for a non-precision FATO.

Table A-4. Dimensions and slopes of the obstacle protection surface

<i>Surfaces and dimensions</i>	<i>Non-precision FATO</i>	
Length of inner edge	Width of safety area	
Distance from end of FATO	60 m	
Divergence	15%	
Total length	2 500 m	
Slope	PAPI	$A^a - 0.57^\circ$
	HAPI	$A^b - 0.65^\circ$
	APAPI	$A^a - 0.9^\circ$

a. As indicated in Civil Aviation Directive 14, Vol. I, Figure 5-19.

b. The angle of the upper boundary of the “below slope” signal.